

R E P O R T

HS-OP470ARH – Low Dose Rate Testing @ 36 rad h⁻¹ ESTEC - Contract No. 22051/08/NL/PA

Project Coordinator: Peter Beck

Project Team: Michael Wind
Marcin Latocha

ESA Technical Project Officer: Marc Poizat

1 Document Approval Sheet

Document title:	HS-OP470ARH – Low Dose Rate Testing @ 36 rad h ⁻¹
Document number:	ELDRS_AIT_LDR-C_HS-OP470ARH_vers1.0.docx
Issue:	1
Revision:	0

Prepared by:	
	Name: Michael Wind
Released by:	
	Name: Peter Beck
Approved by:	
	Name: Marc Poizat

2 Document Change Record

Issue/ Revision	Date	Affected section	Description
1/0	01/12/2011	All	First issue

3 Distribution List

Institution		Copies
AIT	Dr. Peter Beck	1
	Dr. Michael Wind	1
	DI Marcin Latocha	1
ESA	Dr. Marc Poizat	1
	Dr. Ali Zadeh	1

This is a controlled document. Changes and revisions will be issued, as they are approved, to holders of this document.

4 Content

1	Document Approval Sheet	2
2	Document Change Record	3
3	Distribution List	4
4	Content	5
5	List of Abbreviations	6
6	Scope and Objectives	7
7	General Overview of the Measurements	8
8	DUT properties and Sample Enumeration	9
9	Biasing Conditions	10
10	Exposure Plan for Low Dose Rate Testing and Cumulative Dose Levels	10
11	Measured Low Dose Rate Data	11
12	Test Plan – Summary	12
13	References	13
Annex A:	Reference data obtained with the LM324AN microcircuit	14

5 List of Abbreviations

AIT	Austrian Institute of Technology
CMRR	Common Mode Rejection Ratio
CNS	Centre National d'Études Spatiales
CTB	Component Technological Board
CTR	Current Transfer Ratio
DIL	Dual In Line
DEL	Dosimetry Eichlabor (Dosimetry Laboratory)
DUT	Device Under Test
EEE	Electrical Electronic Electromechanical
ELDRS	Enhanced Low Dose Rate Sensitivity
ESA	European Space Agency
ESCC	European Space Component Coordination
ESTEC	European Space Research and Technology Centre
HDR	High Dose Rate
HDR-S	High Dose Rate – exposure of the switching experiment
HZL	Hot Cell Laboratory
IC	Integrated Circuit
LDR	Low Dose Rate
LDR-C	Low Dose Rate – Continuous exposure
LDR-S	Low Dose Rate – exposure of the switching experiment
LET	Linear Energy Transfer
NES	Nuclear Engineering Seibersdorf GmbH
OTA	Operational Transconductance Amplifier
PCB	Printed Circuit Board
PSRR	Power Supply Rejection Ratio
RD	Reference Document
RWG	Radiation Working Group
SCADUS	Smart Control and Development Universal Software
SOW	Statement Of Work
SR	Slew Rate
TID	Total Ionizing Dose
TRR	Test Readiness Review
TN	Technical Note
VEE	Visual Engineering Environment
WO	Work Order
WP	Work Package

6 Scope and Objectives

This report journalizes low dose rate measurements conducted with the HS-OP470ARH microcircuit at a dose rate of $36 \text{ rad}_{(Si)} \text{ h}^{-1}$. Results obtained from these measurements serve as a reference for an experiment that is investigating the accelerated switching test method (see [BOC04], [BOC05], [DUS08], and [BOC09]). The low dose rate degradation is measured for an extensive set of parameters.

This report serves as measurement protocol and a detailed reference data collection. In detail this report includes:

- General overview of the measurements
- Information on DUT properties (e.g. manufacturer, date code, lot ID)
- Enumeration of the DUTs (naming conventions) during the experiments
- Exposure plan
- Dose levels received by each DUT during the exposure
- Measured low dose rate data for each unit and each characterized parameter

7 General Overview of the Measurements

The low dose rate exposure is using a constant dose rate Co-60 photon field with a dose rate of approximately $10 \text{ mrad}_{(Si)} \text{ s}^{-1}$. The exposure is only interrupted for characterisation of the DUTs, which are performed on average every three to four weeks. In terms of total dose this means that a characterisation is done approximately every $20 \text{ krad}_{(Si)}$. 115 days of continuous exposure are needed to reach the specified total dose level of $100 \text{ krad}_{(Si)}$.

All units are mounted on one PCB that is presented in Figure 1. It is noted that this PCB is used also for other experiments that are carried out in parallel. Biased units are positioned in the centre of the board. They are arranged in columns of five units, in each column the biased units of one device type is mounted. To the left and to the right the unbiased units are mounted on antistatic foam that is wrapped in aluminium. This ensures that all pins are grounded. The pin to ground resistance is typical less than 4Ω . A RadFET dosimeter is used to monitor the dose received by the DUTs.

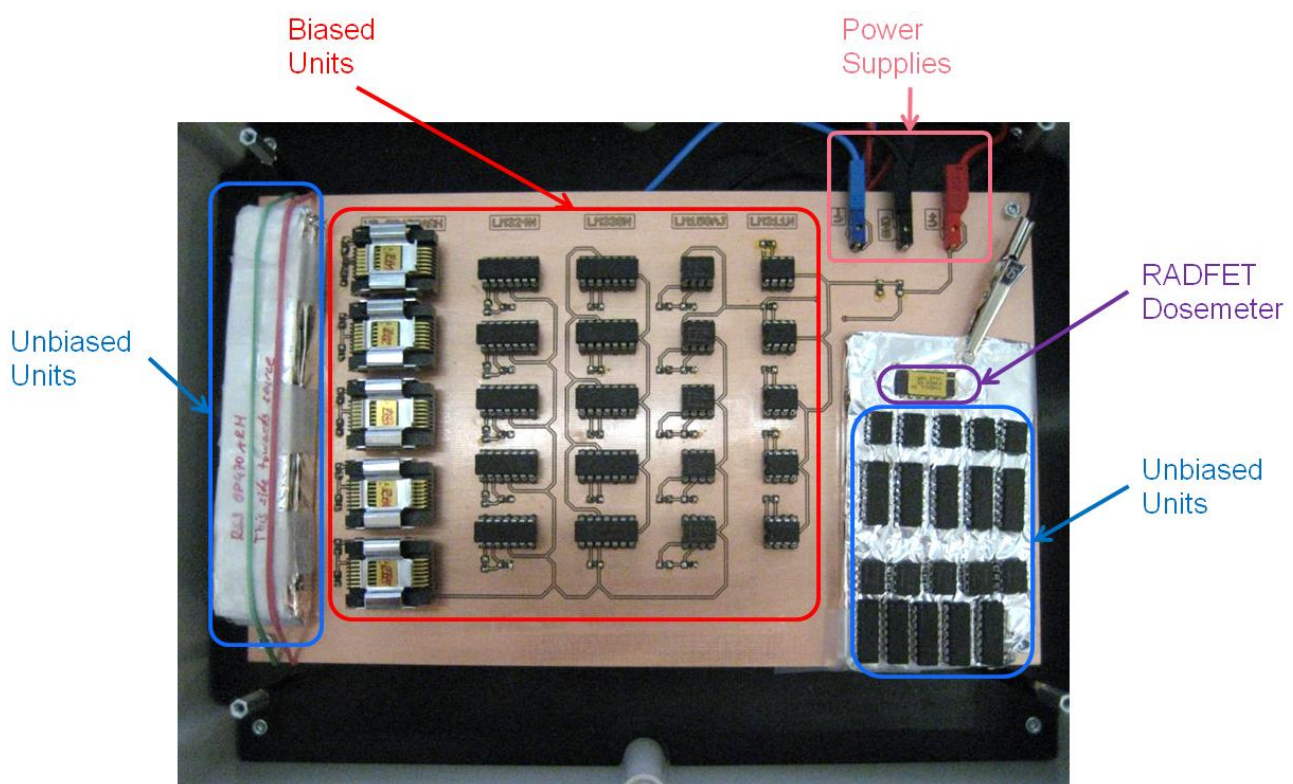

Figure 1: Printed circuit board housing all the biased and unbiased units used for the reference measurements during exposure.

The Co-60 source used for the exposure has an activity of 16.41 Ci (607 GBq); the source is mounted in a portable housing that is a gamma ray radiography camera, i.e. in a Gammamat TK-30. The required dose rate of $10 \text{ mrad}_{(Si)} \text{ s}^{-1}$ is available at a distance of approximately 70 cm from the point source.

The source is kept in a shielding made from depleted Uranium encircled by a stainless steel housing. The source can be moved in and out from the shielding via a locating channel. The source is turned off when it is completely retracted and the Uranium shutter is closed. For exposure the shutter is opened and the source is moved within the locating channel into a defined position. The result is a defined radiation field with the shape of a cone. The field will be adjusted in such a way, that it is sufficiently large to irradiate three irradiation boards in parallel. A picture of the setting is shown in Figure 2.

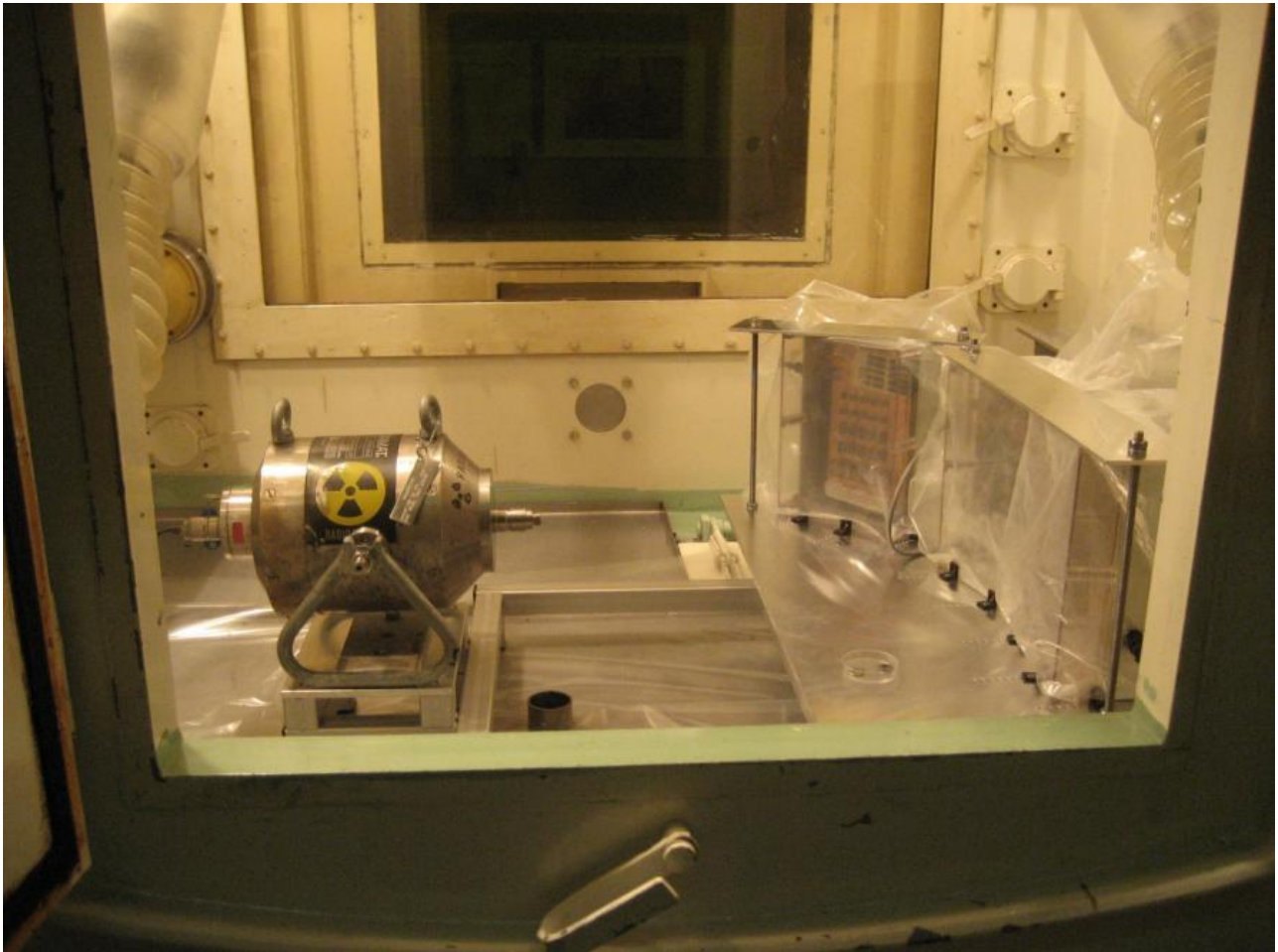

Figure 2: Low dose rate facility; on the left side the radiography camera is positioned, on the right side up to three boxes can be mounted that house one PCB each. The PCB used for the experiments reported here is mounted in the leftmost box.

8 DUT properties and Sample Enumeration

Ten units of the HS-OP470ARH microcircuit are used for the low dose rate exposure; five units are exposed in biased condition and another five units are exposed in unbiased condition (see Section 9). Some basic device properties are presented in Table 1.

Table 1: Manufacturer, data code, and lot of the units used for reference exposure

Device Type	Manufacturer	D/C	LOT
HS-OP470ARH	Intersil		DCEVVJA

The units used for the low dose rate exposures are divided in two groups five units each. One group is exposed in biased condition, the other group in unbiased condition. All the five samples of either group are treated identically. Enumeration of the samples is shown in Table 2.

Table 2: Enumeration of the samples

Exposure Series / Dose Rate	Biasing Condition	Enumeration
Low Dose Rate / 36 rad _(Si) h ⁻¹	biased	BRef1, BRef2, BRef3, BRef4, BRef5
	unbiased	URef1, URef2, URef3, URef4, URef5

9 Biasing Conditions

Tests are conducted in biased and unbiased configuration. In the unbiased configuration all terminals of the microcircuits are held at ground potential. When using biased condition the microcircuits are driven under typical operational conditions. The test circuitry used for the experiments is described in the following.

9.1 Unbiased Configuration

The pins of the microcircuit are held at ground potential during the exposure to the ionizing radiation. Hereby they are mounted in antistatic foam that is enwrapped in aluminium foil. The foil itself is connected to ground potential. The pin to ground resistance is typical well below a few Ohms.

9.2 Biased Configuration

The HS-OP470ARH microcircuit is an operational amplifier that is biased in a non inverting DC gain configuration. Dual voltage supply is used; the positive and negative supply voltages are kept large at $\pm 15V$. The loop gain of the devices is small enough not to drive the amplifier into saturation. V_{in} is set to to 0.5V, the loop gain is roughly 11 (for details see section 12).

10 Exposure Plan for Low Dose Rate Testing and Cumulative Dose Levels

The low dose rate applied to all units during the low dose rate exposure is 10 mrad_(Si) s⁻¹. The exposures are performed in steps of approximately 20 krad_(Si). In between two of such steps the DUTs are removed from the facility and transferred to the lab. An extensive parametric device characterisation is performed to investigate the low dose rate radiation response of the DUTs. After characterisation all the units are remounted in the irradiation facility and the exposure is continued.

Table 3 presents a time table of all exposure steps and the length of the breaks, during which parametric device characterization is done. The cumulative dose to which the DUTs were exposed (at the end of each exposure setup) is presented in the rightmost column.

Table 3: Time table of the low dose rate exposure steps and cumulative dose levels to which the DUTs have been exposed.

Action #	Date	Exposure Stop	Exposure Resume	Duration of Interruption	Cumulative Dose Level
1	12 th December 2010	-----	16:00	-----	0.00 krad _(Si)
2	22 nd December 2010	13:25	15:45	2:20	12.17 krad _(Si)
3	12 th January 2011	13:00	16:00	3:00	28.19 krad _(Si)
4	20 th January 2011	13:15	16:00	2:45	34.18 krad _(Si)
5	17 th February 2011	13:00	16:05	3:05	55.61 krad _(Si)
6	4 th April 2011	10:00	-----	-----	90.10 krad _(Si)

11 Measured Low Dose Rate Data



The parametric device degradation of all units is measured with a parameter analyzer. Measurement Data are presented as parameter value vs. dose (in units of $\text{krad}_{(Si)}$) for all parameters presented in Table 4. Data are presented as tabled values as well as in plots. For each device type and biasing condition five units are irradiated under identical conditions. The tabled data present the results of all five units as well as average values and the standard deviations. In the plots only the average values are presented. Uncertainty bars are calculated as the standard deviation.

The reference data obtained for HS-OP470ARH microcircuit is presented in Annex A: Reference data obtained with the HS-OP470ARH microcircuit.

Table 4: Parametes measured

Electric Parameter used for the characterization of the low dose rate degradation	Symbol
Offset Voltage	V_{OS}
Positive Supply Current	I_{S+}
Negative Supply Current	I_{S-}
Input Bias Current at the Non Inverting Input	I_{b+}
Input Bias Current at the Inverting Input	I_{b-}
Input Bias Current	I_b
Input Offset Current	I_{OS}
Open Loop Gain	A_{VO}
Common Mode Rejection Ration	CMRR
Positive Power Supply Rejection Ratio	PSRR
Negative Power Supply Rejection Ratio	PSRR-
Positive Output Voltage Swing	V_{O+}
Negative Output Voltage Swing	V_{O-}
Positive Short Circuit Current	I_{SC+}
Negative Short Circuit Current	I_{SC-}
Slew Rate	SR

12 Test Plan – Summary

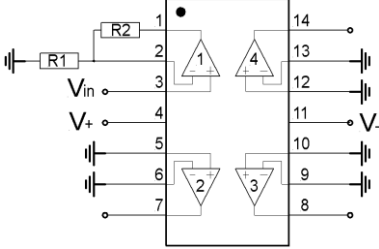
				Total Dose Test Report For: HS-OP470ARH	
Family: Operational Amplifier		Lot Code: DCEVVJA		Manufacturer: Intersil	
Package: Flatpack		Manufacturing Date Code:		Contact Person: Nick van Vonno Address: 1001 Murphy Ranch Road, Milpatis, CA 95035, USA	
Test Facility Name: Nuclear Engineering Seibersdorf GesmbH		Irradiation Test Plan: No.: AIT-5 Iss.: 1 Rev.: 0			
Address: Forschungszentrum Seibersdorf, Seibersdorf, A-2444					
Irradiation Conditions: Biased (In-Situ) & Unbiased		Biased Configuration: Supply Voltages: $V_{\pm}: \pm 15V$ $V_{in}: 0.5V$		Schematic of Test Circuitry: 	
Electrical Measurement:		Resistors: $R_1: 1k\Omega, R_2: 10k\Omega$			
Parameters Tested: $V_{OS}, I_{S+}, I_{S-}, I_{b+}, I_{b-}, I_{b}, I_{OS}, A_{VO}, CMRR, PSRR, PSRR-, V_{O+}, V_{O-}, I_{sc+}, I_{sc-}, SR$		Unbiased Configuration: All terminals grounded; pin to ground resistance typically $< 4 \Omega$			
Temp: 26 °C					
Facilities: Hot Cell Laboratory of the Nuclear Engineering Seibersdorf GesmbH					
Source: gamma		Energy: Co-60 (1.17 MeV, 1.33MeV)		Dose Rate: $8.94 \text{ mrad}_{(Si)} \text{ s}^{-1}$	
Absorber Material: PMMA		Thickness: 3mm		Duration: 129.5 d	
Anneal Test: No					
Irradiation Sequence					
Step No.	Description	Begin	End	Exposure Time	
1	Long term exposure Exposure is interrupted several times for ~2 hours for characterization of the electrical parameters. Electrical characterization is done at dose levels of: 12.2, 28.2, 34.2, 55.6, and 90.1 $\text{krad}_{(Si)}$	7 th Dec 2010	4 th April 2011	118 d	
Irradiation Test Facility: Responsible Name: Michael Wind Telephone: +43 (0) 50550 - 4310			Electrical Test: Responsible Name: Michael Wind Telephone: +43 (0) 50550 - 4310		

13 References

- BOC04 J. Boch, F. Saigné, R.D. Schrimpf, D.M. Fleetwood, S. Ducret, L. Dusseau, J.P., David, J. Fesquet, J. Gasiot, R. Ecoffet, Effect of Switching From High to Low Dose Rate on Linear Bipolar Technology Radiation response, IEEE-TNS, vol.51(5), p.2896, October 2004
- BOC05 J. Boch, F. Saigné, R.D. Schrimpf, J.-R. Vaillé, L. Dusseau, S. Ducret, M. Bernard, E. Lorfèvre, and C. Chatry, Estimation of Low-Dose-Rate Degradation on Bipolar Linear Integrated Circuits Using Switching Experiments, IEEE-TNS, vol. 52 (6), p. 2616, December 2005
- BOC09 J. Boch, Y. Gonzalez Velo, F. Saigné, N. J-H. Roche, R.D. Schrimpf, J.-R. Vaillé, L. Dusseau, C. Chatry, E. Lorfèvre, R. Ecoffet, A.D. Touboul, The use of a Dose- Rate Switching Technique to Characterize Bipolar Devices, submitted to IEEE-TNS, accepted for NSREC, 2009
- DUS08 L. Dusseau, M. Bernard, J. Boch, Y. Gonzalez velo, N. Roche, E. Lorfèvre, F. Bezerra, P. Calvel, R. Marec, F. Saigné, Review and Analysis of the Radiation - Induced Degradation Observed for the Input Bias Current of Linear Integrated Circuits, IEEE-TNS, vol. 55 (6), p.3174, December 2008
- INT98 Intersil, HS-OP470ARH, Radiation Hardened, Very Low Noise Quad Operational Amplifier, datasheet 1998

Annex A: Reference data obtained with the HS-OP470ARH microcircuit

Raw Data	Device Type: HS-OP470ARH	Parameter: Vos (mV)	Biasing Condition: Biased				
LDR-C Reference	Dose (krad)	0.00	12.16	34.37	55.80	69.59	91.03
	BRef1	0.59	0.06	0.02	-0.00	-0.00	-0.02
	BRef2	0.22	0.21	0.24	0.37	0.43	0.54
	BRef3	0.58	0.53	0.49	0.47	0.46	0.45
	BRef4	0.46	0.43	0.40	0.38	0.37	0.36
	BRef5	0.31	0.30	0.35	0.43		
	Mean	0.43	0.31	0.30	0.33	0.31	0.33
	StdDev	0.16	0.18	0.18	0.19	0.22	0.25

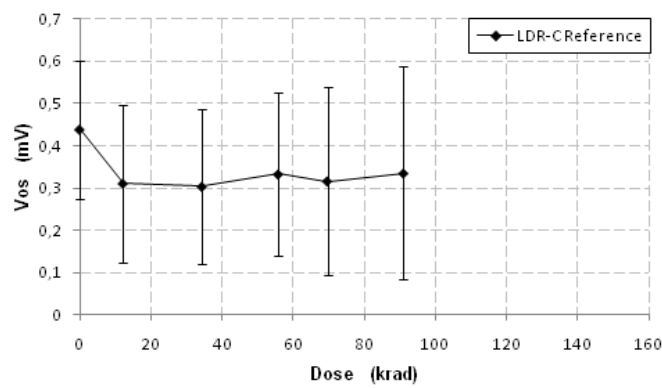

Raw Data	Device Type: HS-OP470ARH	Parameter: Is+ (mA)	Biasing Condition: Biased				
LDR-C Reference	Dose (krad)	0.00	12.16	34.37	55.80	69.59	91.03
	BRef1	3.22	3.28	3.13	3.01	2.97	2.86
	BRef2	3.29	3.28	3.14	2.97	2.88	2.77
	BRef3	3.24	3.24	3.12	2.99	2.91	2.80
	BRef4	3.51	3.47	3.15	3.02	2.99	2.88
	BRef5	3.55	3.52	3.17	3.03		
	Mean	3.36	3.36	3.14	3.00	2.94	2.82
	StdDev	0.15	0.12	0.01	2.09E-02	5.01E-02	5.14E-02

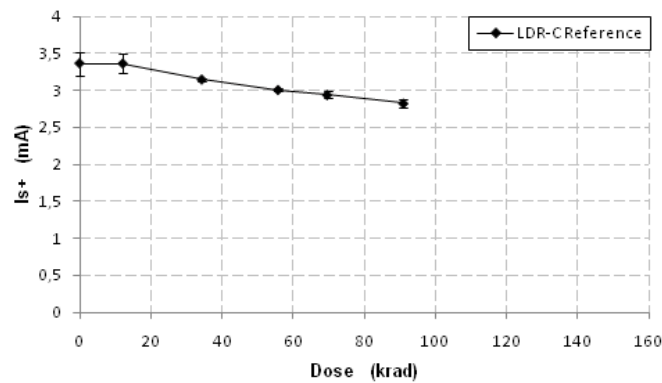

Raw Data	Device Type: HS-OP470ARH	Parameter: Is- (mA)	Biasing Condition: Biased				
LDR-C Reference	Dose (krad)	0.00	12.16	34.37	55.80	69.59	91.03
	BRef1	-3.13	-3.21	-3.07	-2.94	-2.89	-2.79
	BRef2	-3.21	-3.21	-3.07	-2.90	-2.79	-2.69
	BRef3	-3.15	-3.17	-3.07	-2.93	-2.83	-2.72
	BRef4	-3.26	-3.25	-3.09	-2.95	-2.90	-2.80
	BRef5	-3.30	-3.30	-3.10	-2.95		
	Mean	-3.21	-3.23	-3.08	-2.94	-2.85	-2.75
	StdDev	7.25E-02	4.90E-02	1.56E-02	2.00E-02	5.15E-02	5.13E-02

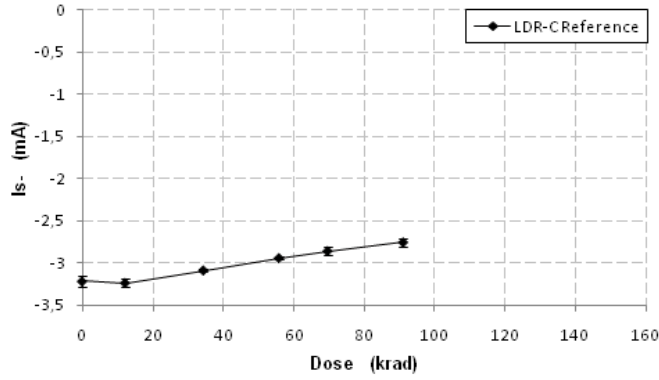

Raw Data	Device Type: HS-OP470ARH	Parameter: Ib+ (uA)	Biasing Condition: Biased				
LDR-C Reference	Dose (krad)	0.00	12.16	34.37	55.80	69.59	91.03
	BRef1	0.03	0.05	0.09	0.11	0.11	0.11
	BRef2	0.04	0.06	0.13	0.24	0.28	0.34
	BRef3	0.05	0.06	0.11	0.12	0.13	0.13
	BRef4	0.04	0.05	0.08	0.10	0.10	0.11
	BRef5	0.04	0.06	0.16	0.24		
	Mean	0.04	0.06	0.12	0.16	0.16	0.17
	StdDev	5.91E-03	8.64E-03	3.21E-02	7.15E-02	8.45E-02	0.11

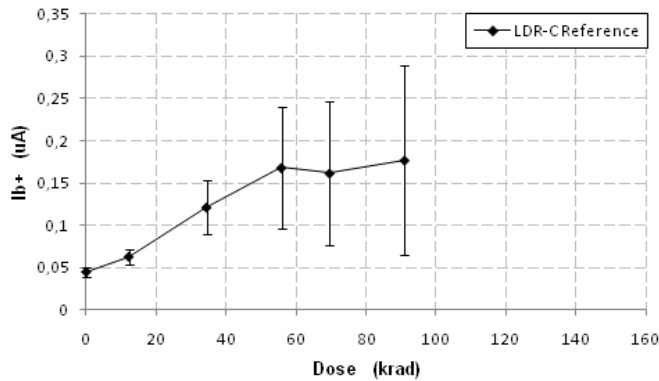

Raw Data — Device Type: HS-OP470ARH Parameter: Ib- (uA) Biasing Condition: Biased

LDR-C Reference	Dose (krad)	0.00	12.16	34.37	55.80	69.59	91.03
	BRef1	0.03	0.06	0.09	0.11	0.11	0.12
	BRef2	0.04	0.04	0.06	-0.03	-0.09	-0.15
	BRef3	0.04	0.06	0.09	0.11	0.11	0.12
	BRef4	0.03	0.04	0.08	0.09	0.09	0.10
	BRef5	0.04	0.04	0.01	-0.05		
	Mean	0.04	0.05	0.07	0.04	0.05	0.04
	StdDev	6.08E-03	8.23E-03	3.48E-02	8.49E-02	0.10	0.13

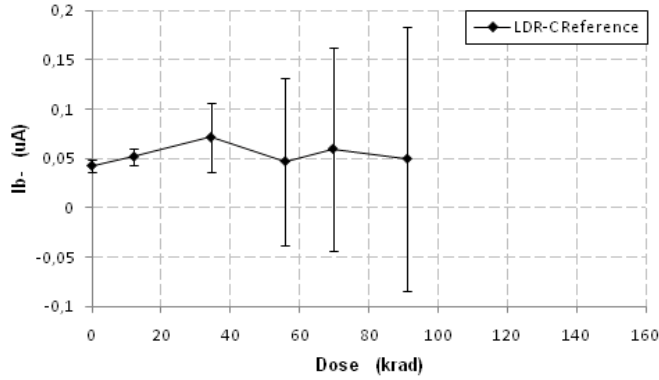

Raw Data — Device Type: HS-OP470ARH Parameter: Ib (uA) Biasing Condition: Biased

LDR-C Reference	Dose (krad)	0.00	12.16	34.37	55.80	69.59	91.03
	BRef1	0.03	0.05	0.09	0.11	0.11	0.11
	BRef2	0.04	0.05	0.10	0.10	0.09	0.09
	BRef3	0.05	0.06	0.10	0.12	0.12	0.12
	BRef4	0.03	0.04	0.08	0.10	0.10	0.10
	BRef5	0.04	0.05	0.09	0.09		
	Mean	0.04	0.05	0.09	0.10	0.11	0.11
	StdDev	5.94E-03	4.99E-03	7.45E-03	9.77E-03	1.30E-02	1.31E-02

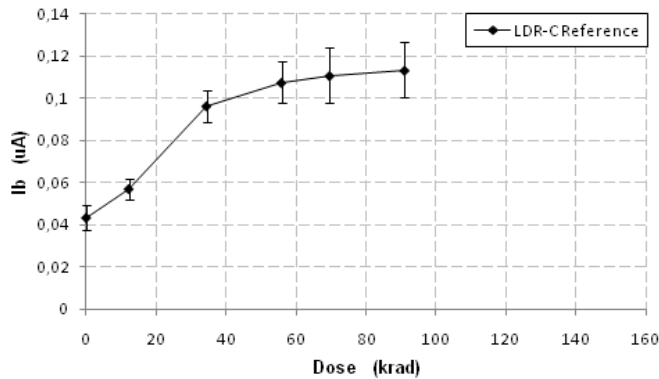

Raw Data		Device Type: HS-OP470ARH		Parameter: Ios (uA)		Biasing Condition: Biased	
LDR-C Reference	Dose (krad)	0.00	12.16	34.37	55.80	69.59	91.03
	BRef1	0.00	-0.00	-0.00	-0.00	-0.00	-0.00
	BRef2	0.00	0.02	0.08	0.28	0.37	0.49
	BRef3	0.00	0.00	0.00	0.00	0.00	0.00
	BRef4	0.00	0.00	0.00	0.00	0.00	0.00
	BRef5	0.00	0.02	0.15	0.29		
	Mean	0.00	0.01	0.04	0.11	0.09	0.12
	StdDev	1.12E-03	0.01	6.77E-02	0.15	0.18	0.24

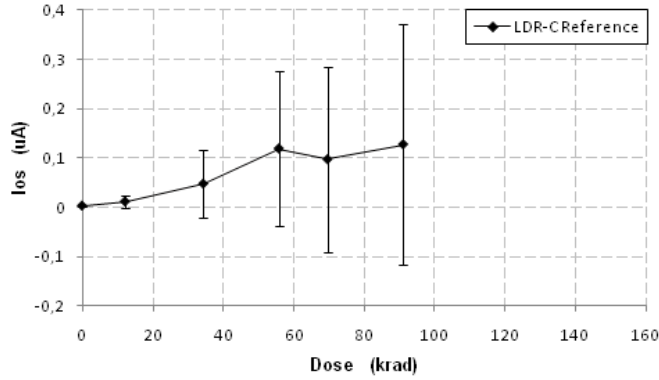

Raw Data		Device Type: HS-OP470ARH		Parameter: Av0 (dB)		Biasing Condition: Biased	
LDR-C Reference	Dose (krad)	0.00	12.16	34.37	55.80	69.59	91.03
	BRef1	109.5	113.5	108.5	106.3	105.7	105.1
	BRef2	112.7	115.7	110.3	108	106.8	106.1
	BRef3	111.5	114.6	108.5	105.5	106.1	104.8
	BRef4	109.3	113	108.9	106.3	105.8	105.1
	BRef5	110.9	112.9	109	107.2		
	Mean	110.78	113.94	109.04	106.66	106.1	105.27
	StdDev	1.41	1.19	0.74	0.96	0.49	0.56

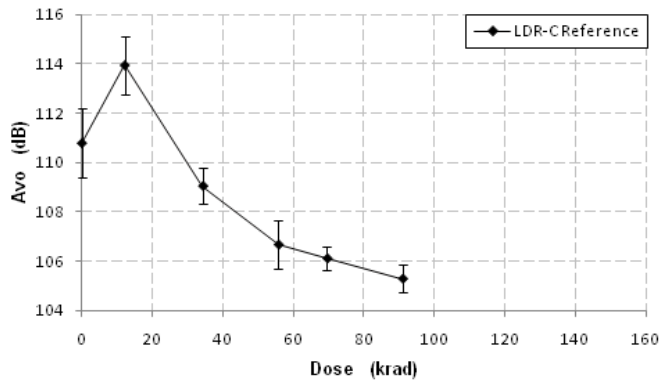

Raw Data — Device Type: HS-OP470ARH Parameter: CMRR (dB) Biasing Condition: Biased

LDR-C Reference	Dose (krad)	0.00	12.16	34.37	55.80	69.59	91.03
	BRef1	96.61	100.4	100.2	100.1	100.2	100.2
	BRef2	97.34	97.83	97.77	97.87	97.97	98.39
	BRef3	96.87	97.4	97.36	97.36	97.17	97.28
	BRef4	96.6	97.12	97.14	96.98	96.97	97.11
	BRef5	96.93	97.84	98.11	98.21		
	Mean	96.87	98.11	98.11	98.10	98.07	98.24
	StdDev	0.30	1.31	1.22	1.21	1.47	1.42

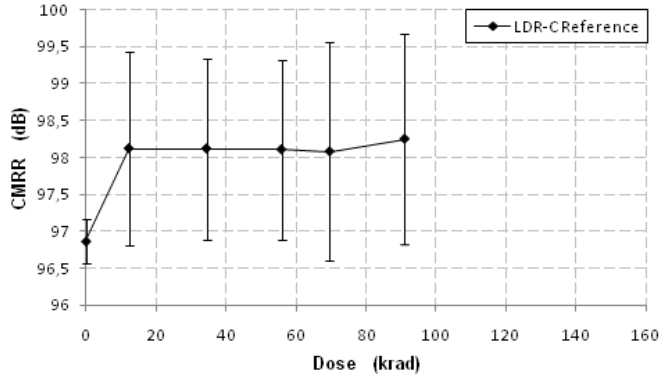

Raw Data — Device Type: HS-OP470ARH Parameter: PSRR (dB) Biasing Condition: Biased

LDR-C Reference	Dose (krad)	0.00	12.16	34.37	55.80	69.59	91.03
	BRef1	95.81	98.1	96.85	95.89	95.49	95.22
	BRef2	97.13	96.58	95.76	95.81	95.76	96.3
	BRef3	96.47	95.99	94.7	94.13	93.84	93.79
	BRef4	96.53	95.88	94.86	94.23	93.78	93.73
	BRef5	97.01	96.77	95.83	95.43		
	Mean	96.59	96.66	95.6	95.09	94.71	94.76
	StdDev	0.52	0.88	0.86	0.85	1.05	1.23

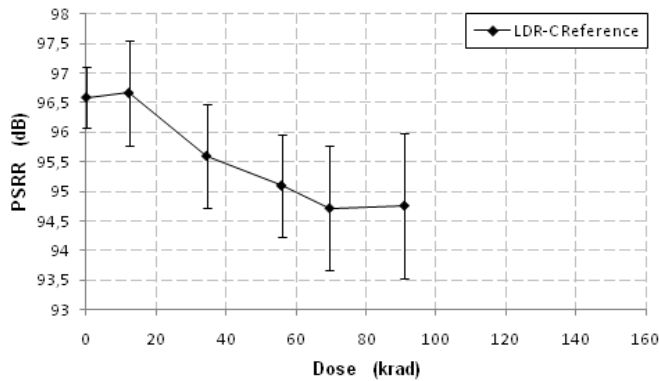

Raw Data	Device Type: HS-OP470ARH	Parameter: PSSR- (dB)	Biasing Condition: Biased				
LDR-C Reference	Dose (krad)	0.00	12.16	34.37	55.80	69.59	91.03
	BRef1	97.55	100.9	101.1	100.5	100.9	100.9
	BRef2	98.29	97.94	98.36	98.87	99.16	99.87
	BRef3	97.84	97.75	97.76	97.88	98.07	98.19
	BRef4	97.69	97.17	97.54	97.62	97.49	98.14
	BRef5	98.48	98.38	98.74	99.09		
	Mean	97.97	98.42	98.7	98.79	98.90	99.27
	StdDev	0.39	1.44	1.42	1.14	1.49	1.34

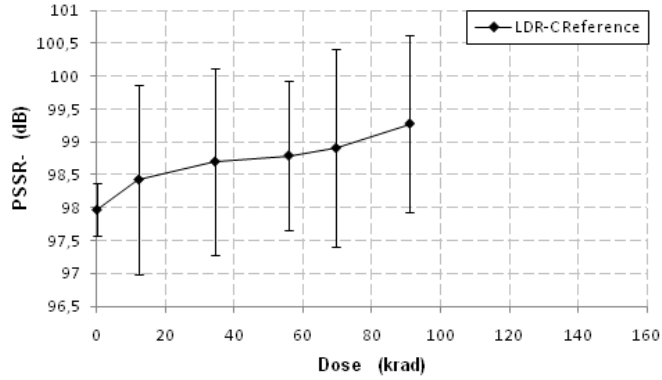

Raw Data	Device Type: HS-OP470ARH	Parameter: Vo+ (V)	Biasing Condition: Biased				
LDR-C Reference	Dose (krad)	0.00	12.16	34.37	55.80	69.59	91.03
	BRef1	13.61	13.56	13.53	13.53	13.54	13.54
	BRef2	13.6	13.57	13.56	13.56	13.57	13.58
	BRef3	13.6	13.56	13.54	13.54	13.54	13.55
	BRef4	13.61	13.57	13.55	13.55	13.55	13.55
	BRef5	13.58	13.55	13.54	13.55		
	Mean	13.6	13.56	13.54	13.54	13.55	13.55
	StdDev	1.22E-02	8.36E-03	0.01	0.01	1.41E-02	1.73E-02

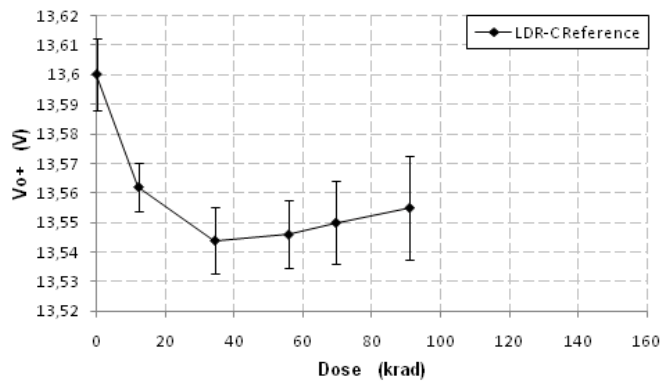

Raw Data		Device Type: HS-OP470ARH		Parameter: Vo- (V)		Biasing Condition: Biased	
LDR-C Reference	Dose (krad)	0.00	12.16	34.37	55.80	69.59	91.03
	BRef1	-13.56	-13.51	-13.49	-13.48	-13.49	-13.49
	BRef2	-13.56	-13.52	-13.49	-13.48	-13.49	-13.5
	BRef3	-13.56	-13.52	-13.49	-13.48	-13.49	-13.5
	BRef4	-13.56	-13.52	-13.5	-13.49	-13.49	-13.51
	BRef5	-13.56	-13.52	-13.49	-13.48	-13.48	-13.48
	Mean	-13.56	-13.51	-13.49	-13.48	-13.49	-13.5
	StdDev	1.98E-15	4.47E-03	4.47E-03	4.47E-03	0.00	8.16E-03

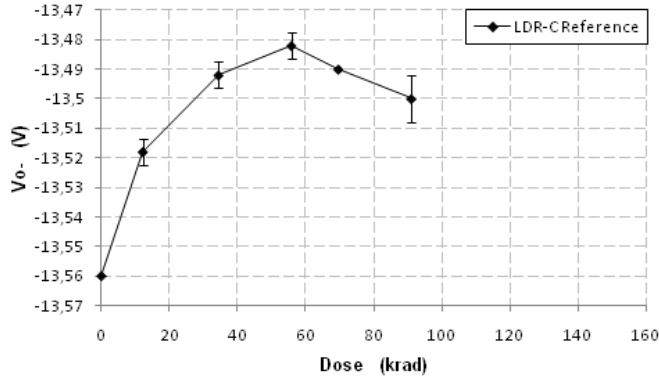

Raw Data		Device Type: HS-OP470ARH		Parameter: Isc+ (mA)		Biasing Condition: Biased	
LDR-C Reference	Dose (krad)	0.00	12.16	34.37	55.80	69.59	91.03
	BRef1	32.02	28.81	27.37	26.24	25.62	24.77
	BRef2	29.18	28.56	27.81	26.46	25.8	24.99
	BRef3	29.86	29.02	27.51	26.3	25.61	24.68
	BRef4	31.25	30.41	29.09	27.94	27.3	26.46
	BRef5	30.35	29.5	28.17	27.1	26.3	25.61
	Mean	30.53	29.26	27.99	26.80	26.08	25.22
	StdDev	1.12	0.72	0.68	0.71	0.81	0.83

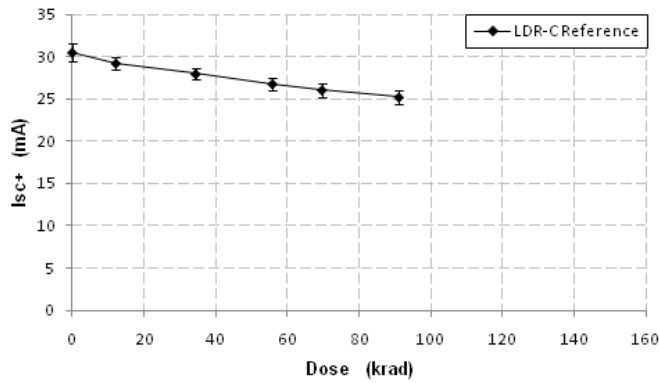

Raw Data	Device Type: HS-OP470ARH	Parameter: I _{sc} (mA)	Biasing Condition: Biased				
LDR-C Reference	Dose (krad)	0.00	12.16	34.37	55.80	69.59	91.03
	BRef1	-27.47	-24.43	-21.52	-19.05	-18.02	-16.67
	BRef2	-25.96	-24.75	-21.38	-17.3	-15.93	-14.3
	BRef3	-25.81	-24.69	-22.21	-19.74	-18.5	-17.15
	BRef4	-26.91	-25.45	-22.27	-19.77	-18.62	-17.33
	BRef5	-26.26	-24.92	-21.32	-17.76		
	Mean	-26.48	-24.84	-21.74	-18.72	-17.76	-16.36
	StdDev	0.69	0.37	0.46	1.13	1.25	1.40

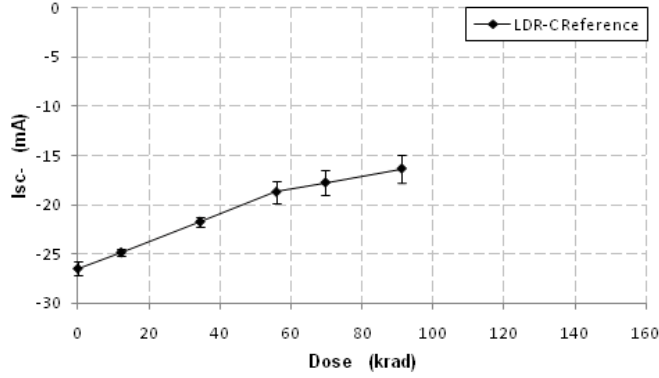

Raw Data	Device Type: HS-OP470ARH	Parameter: SR (V/μsec)	Biasing Condition: Biased				
LDR-C Reference	Dose (krad)	0.00	12.16	34.37	55.80	69.59	91.03
	BRef1	2.19	2.06	1.90	1.85	1.85	1.66
	BRef2	2.06	2.08	1.96	1.85	1.85	1.70
	BRef3	2.12	2	2	1.96	1.96	1.70
	BRef4	2.19	2.02	2	1.90	1.90	1.73
	BRef5	2.19	2.12	1.90	1.78	1.78	
	Mean	2.15	2.05	1.95	1.87	1.87	1.70
	StdDev	6.10E-02	5.08E-02	4.76E-02	6.55E-02	6.55E-02	2.93E-02

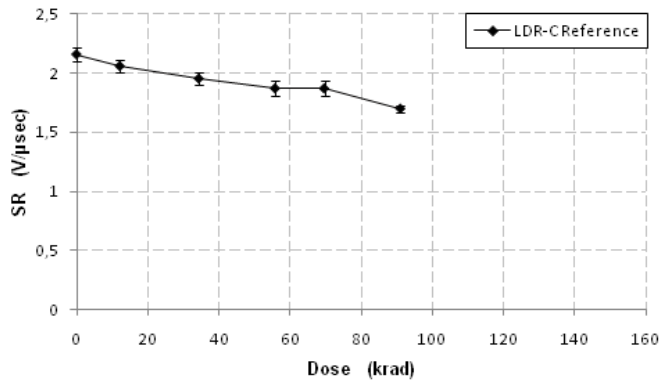

Raw Data	Device Type: HS-OP470ARH	Parameter: Vos (mV)	Biasing Condition: Unbiased				
LDR-C Reference	Dose (krad)	0.00	12.16	34.37	55.80	69.59	91.03
	URef1	0.59	0.06	0.02	-0.00	-0.00	-0.02
	URef2	0.22	0.21	0.24	0.37	0.43	0.54
	URef3	0.58	0.53	0.49	0.47	0.46	0.45
	URef4	0.46	0.43	0.40	0.38	0.37	0.36
	URef5	0.31	0.30	0.35	0.43		
	Mean	0.43	0.31	0.30	0.33	0.31	0.33
	StdDev	0.16	0.18	0.18	0.19	0.22	0.25

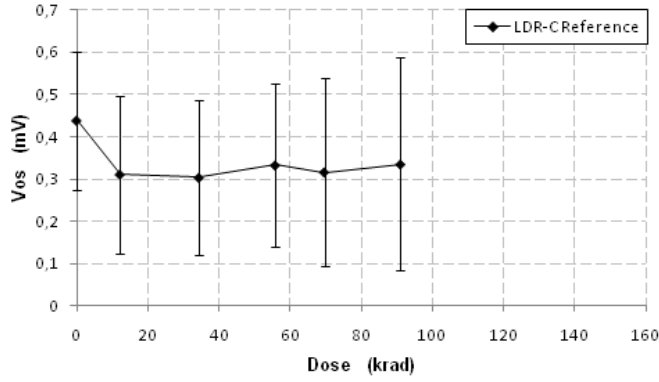

Raw Data	Device Type: HS-OP470ARH	Parameter: Is+ (mA)	Biasing Condition: Unbiased				
LDR-C Reference	Dose (krad)	0.00	12.16	34.37	55.80	69.59	91.03
	URef1	3.22	3.28	3.13	3.01	2.97	2.86
	URef2	3.29	3.28	3.14	2.97	2.88	2.77
	URef3	3.24	3.24	3.12	2.99	2.91	2.80
	URef4	3.51	3.47	3.15	3.02	2.99	2.88
	URef5	3.55	3.52	3.17	3.03		
	Mean	3.36	3.36	3.14	3.00	2.94	2.82
	StdDev	0.15	0.12	0.01	2.09E-02	5.01E-02	5.14E-02

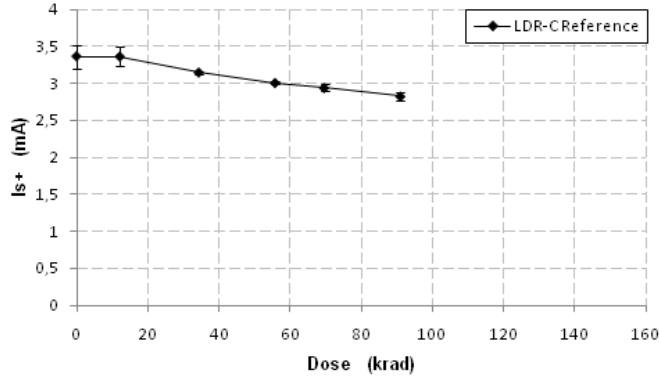

Raw Data	Device Type: HS-OP470ARH	Parameter: Is- (mA)	Biasing Condition: Unbiased				
LDR-C Reference	Dose (krad)	0.00	12.16	34.37	55.80	69.59	91.03
	URef1	-3.13	-3.21	-3.07	-2.94	-2.89	-2.79
	URef2	-3.21	-3.21	-3.07	-2.90	-2.79	-2.69
	URef3	-3.15	-3.17	-3.07	-2.93	-2.83	-2.72
	URef4	-3.26	-3.25	-3.09	-2.95	-2.90	-2.80
	URef5	-3.30	-3.30	-3.10	-2.95		
	Mean	-3.21	-3.23	-3.08	-2.94	-2.85	-2.75
	StdDev	7.25E-02	4.90E-02	1.56E-02	2.00E-02	5.15E-02	5.13E-02

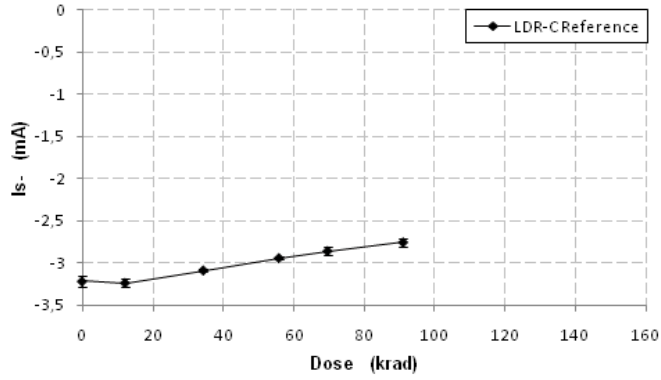

Raw Data	Device Type: HS-OP470ARH	Parameter: Ib+ (uA)	Biasing Condition: Unbiased				
LDR-C Reference	Dose (krad)	0.00	12.16	34.37	55.80	69.59	91.03
	URef1	0.03	0.05	0.09	0.11	0.11	0.11
	URef2	0.04	0.06	0.13	0.24	0.28	0.34
	URef3	0.05	0.06	0.11	0.12	0.13	0.13
	URef4	0.04	0.05	0.08	0.10	0.10	0.11
	URef5	0.04	0.06	0.16	0.24		
	Mean	0.04	0.06	0.12	0.16	0.16	0.17
	StdDev	5.91E-03	8.64E-03	3.21E-02	7.15E-02	8.45E-02	0.11

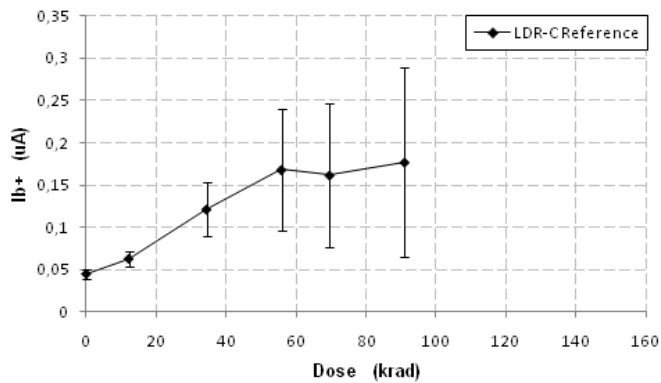

Raw Data	Device Type: HS-OP470ARH	Parameter: Ib- (uA)	Biasing Condition: Unbiased				
LDR-C Reference	Dose (krad)	0.00	12.16	34.37	55.80	69.59	91.03
	URef1	0.03	0.06	0.09	0.11	0.11	0.12
	URef2	0.04	0.04	0.06	-0.03	-0.09	-0.15
	URef3	0.04	0.06	0.09	0.11	0.11	0.12
	URef4	0.03	0.04	0.08	0.09	0.09	0.10
	URef5	0.04	0.04	0.01	-0.05		
	Mean	0.04	0.05	0.07	0.04	0.05	0.04
	StdDev	6.08E-03	8.23E-03	3.48E-02	8.49E-02	0.10	0.13

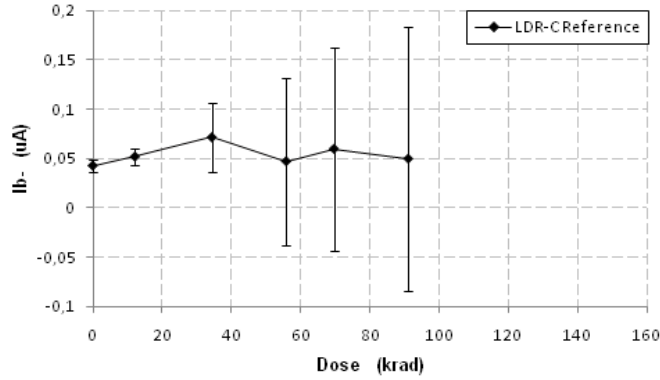

Raw Data	Device Type: HS-OP470ARH	Parameter: Ib (uA)	Biasing Condition: Unbiased				
LDR-C Reference	Dose (krad)	0.00	12.16	34.37	55.80	69.59	91.03
	URef1	0.03	0.05	0.09	0.11	0.11	0.11
	URef2	0.04	0.05	0.10	0.10	0.09	0.09
	URef3	0.05	0.06	0.10	0.12	0.12	0.12
	URef4	0.03	0.04	0.08	0.10	0.10	0.10
	URef5	0.04	0.05	0.09	0.09		
	Mean	0.04	0.05	0.09	0.10	0.11	0.11
	StdDev	5.94E-03	4.99E-03	7.45E-03	9.77E-03	1.30E-02	1.31E-02

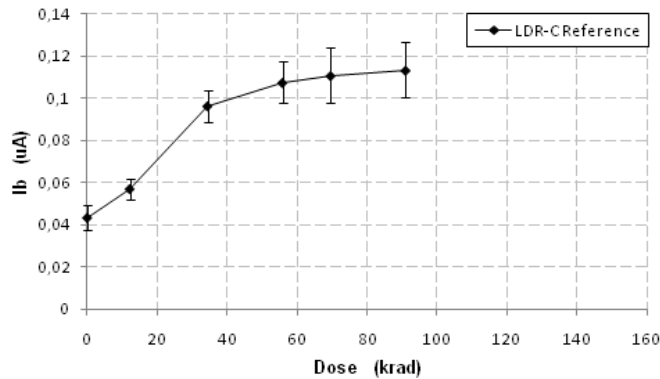

Raw Data	Device Type: HS-OP470ARH		Parameter: Ios (uA)		Biasing Condition: Unbiased		
LDR-C Reference	Dose (krad)	0.00	12.16	34.37	55.80	69.59	91.03
	URef1	0.00	-0.00	-0.00	-0.00	-0.00	-0.00
	URef2	0.00	0.02	0.08	0.28	0.37	0.49
	URef3	0.00	0.00	0.00	0.00	0.00	0.00
	URef4	0.00	0.00	0.00	0.00	0.00	0.00
	URef5	0.00	0.02	0.15	0.29		
	Mean	0.00	0.01	0.04	0.11	0.09	0.12
	StdDev	1.12E-03	0.01	6.77E-02	0.15	0.18	0.24

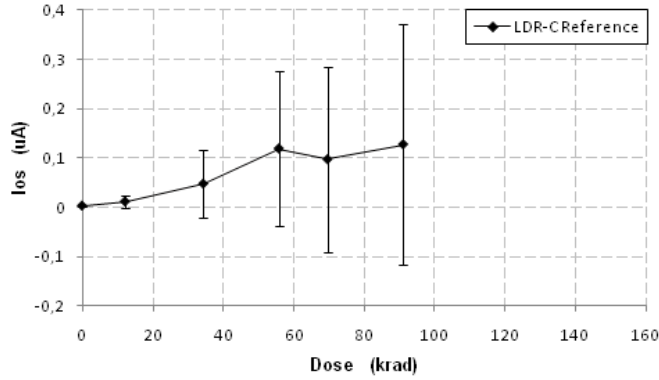

Raw Data	Device Type: HS-OP470ARH		Parameter: Avo (dB)		Biasing Condition: Unbiased		
LDR-C Reference	Dose (krad)	0.00	12.16	34.37	55.80	69.59	91.03
	URef1	109.5	113.5	108.5	106.3	105.7	105.1
	URef2	112.7	115.7	110.3	108	106.8	106.1
	URef3	111.5	114.6	108.5	105.5	106.1	104.8
	URef4	109.3	113	108.9	106.3	105.8	105.1
	URef5	110.9	112.9	109	107.2		
	Mean	110.78	113.94	109.04	106.66	106.1	105.27
	StdDev	1.41	1.19	0.74	0.96	0.49	0.56

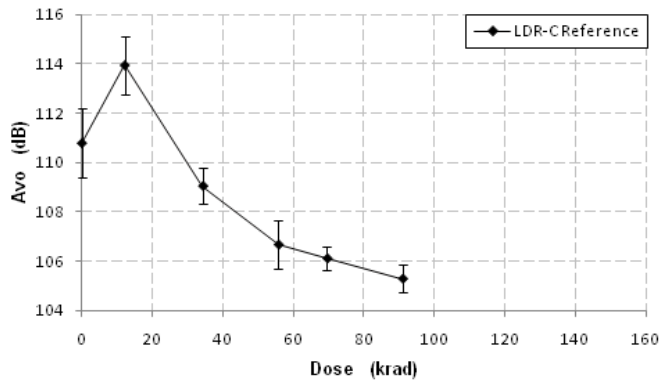

Raw Data	Device Type: HS-OP470ARH	Parameter: CMRR (dB)	Biasing Condition: Unbiased				
LDR-C Reference	Dose (krad)	0.00	12.16	34.37	55.80	69.59	91.03
	URef1	96.61	100.4	100.2	100.1	100.2	100.2
	URef2	97.34	97.83	97.77	97.87	97.97	98.39
	URef3	96.87	97.4	97.36	97.36	97.17	97.28
	URef4	96.6	97.12	97.14	96.98	96.97	97.11
	URef5	96.93	97.84	98.11	98.21		
	Mean	96.87	98.11	98.11	98.10	98.07	98.24
	StdDev	0.30	1.31	1.22	1.21	1.47	1.42

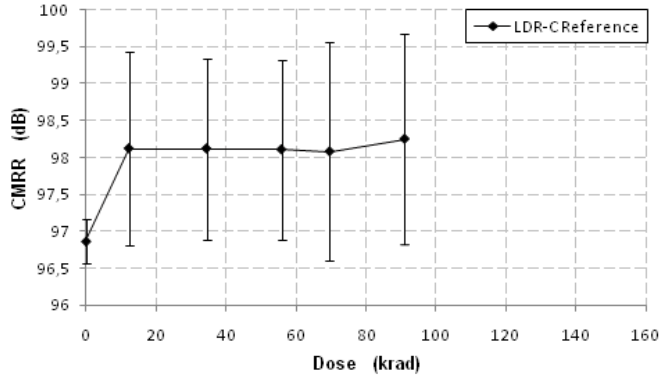

Raw Data	Device Type: HS-OP470ARH	Parameter: PSRR (dB)	Biasing Condition: Unbiased				
LDR-C Reference	Dose (krad)	0.00	12.16	34.37	55.80	69.59	91.03
	URef1	95.81	98.1	96.85	95.89	95.49	95.22
	URef2	97.13	96.58	95.76	95.81	95.76	96.3
	URef3	96.47	95.99	94.7	94.13	93.84	93.79
	URef4	96.53	95.88	94.86	94.23	93.78	93.73
	URef5	97.01	96.77	95.83	95.43		
	Mean	96.59	96.66	95.6	95.09	94.71	94.76
	StdDev	0.52	0.88	0.86	0.85	1.05	1.23

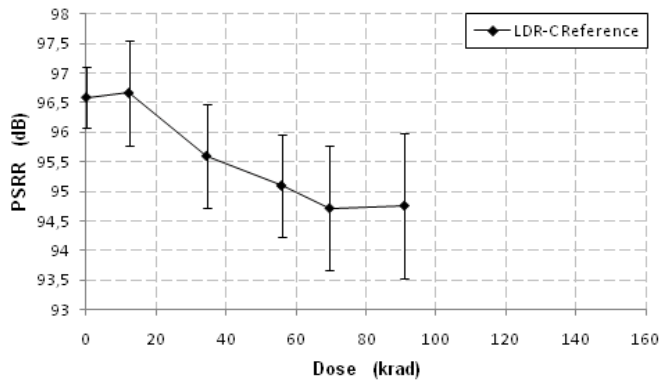

Raw Data	Device Type: HS-OP470ARH	Parameter: PSSR- (dB)	Biasing Condition: Unbiased				
LDR-C Reference	Dose (krad)	0.00	12.16	34.37	55.80	69.59	91.03
	URef1	97.55	100.9	101.1	100.5	100.9	100.9
	URef2	98.29	97.94	98.36	98.87	99.16	99.87
	URef3	97.84	97.75	97.76	97.88	98.07	98.19
	URef4	97.69	97.17	97.54	97.62	97.49	98.14
	URef5	98.48	98.38	98.74	99.09		
	Mean	97.97	98.42	98.7	98.79	98.90	99.27
	StdDev	0.39	1.44	1.42	1.14	1.49	1.34

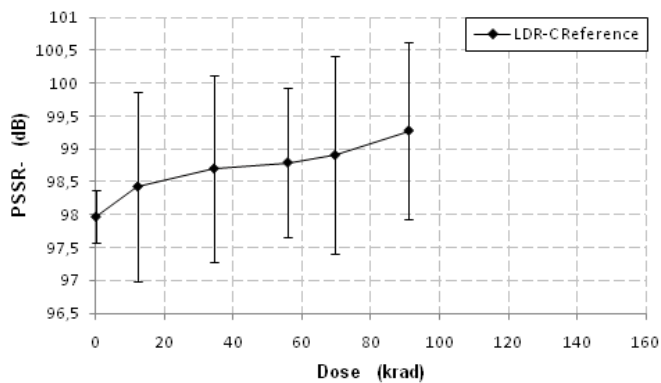

Raw Data	Device Type: HS-OP470ARH	Parameter: Vo+ (V)	Biasing Condition: Unbiased				
LDR-C Reference	Dose (krad)	0.00	12.16	34.37	55.80	69.59	91.03
	URef1	13.61	13.56	13.53	13.53	13.54	13.54
	URef2	13.6	13.57	13.56	13.56	13.57	13.58
	URef3	13.6	13.56	13.54	13.54	13.54	13.55
	URef4	13.61	13.57	13.55	13.55	13.55	13.55
	URef5	13.58	13.55	13.54	13.55		
	Mean	13.6	13.56	13.54	13.54	13.55	13.55
	StdDev	1.22E-02	8.36E-03	0.01	0.01	1.41E-02	1.73E-02

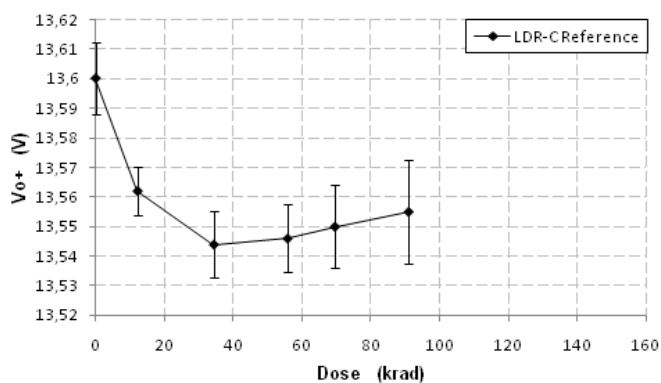

Raw Data — Device Type: HS-OP470ARH Parameter: Vo- (V) Biasing Condition: Unbiased

LDR-C Reference	Dose (krad)	0.00	12.16	34.37	55.80	69.59	91.03
	URef1	-13.56	-13.51	-13.49	-13.48	-13.49	-13.49
	URef2	-13.56	-13.52	-13.49	-13.48	-13.49	-13.5
	URef3	-13.56	-13.52	-13.49	-13.48	-13.49	-13.5
	URef4	-13.56	-13.52	-13.5	-13.49	-13.49	-13.51
	URef5	-13.56	-13.52	-13.49	-13.48	-13.48	-13.48
	Mean	-13.56	-13.51	-13.49	-13.48	-13.49	-13.5
StdDev	1.98E-15	4.47E-03	4.47E-03	4.47E-03	0.00	8.16E-03	

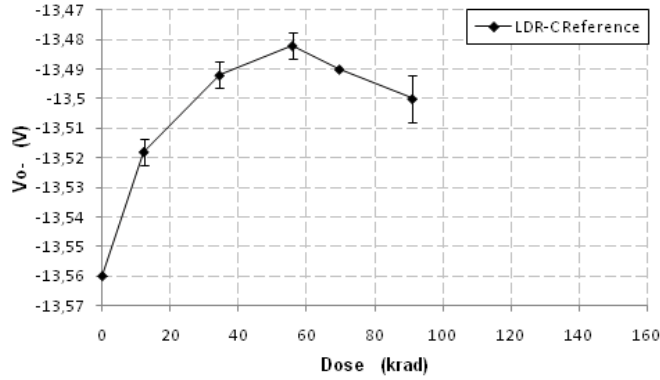

Raw Data — Device Type: HS-OP470ARH Parameter: Isc+ (mA) Biasing Condition: Unbiased

LDR-C Reference	Dose (krad)	0.00	12.16	34.37	55.80	69.59	91.03
	URef1	32.02	28.81	27.37	26.24	25.62	24.77
	URef2	29.18	28.56	27.81	26.46	25.8	24.99
	URef3	29.86	29.02	27.51	26.3	25.61	24.68
	URef4	31.25	30.41	29.09	27.94	27.3	26.46
	URef5	30.35	29.5	28.17	27.1	26.08	25.22
	Mean	30.53	29.26	27.99	26.80	26.08	25.22
StdDev	1.12	0.72	0.68	0.71	0.81	0.83	

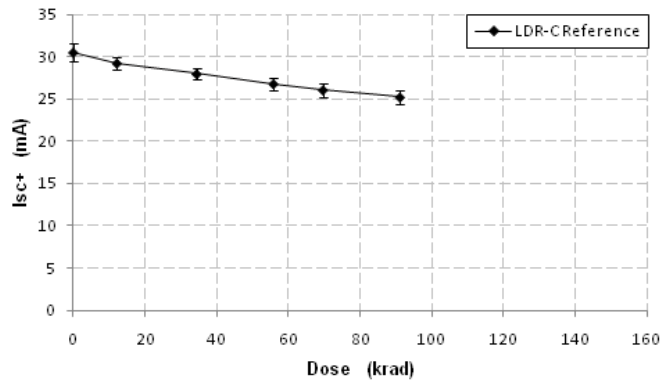

Raw Data	Device Type: HS-OP470ARH		Parameter: Isc- (mA)		Biasing Condition: Unbiased		
LDR-C Reference	Dose (krad)	0.00	12.16	34.37	55.80	69.59	91.03
	URef1	-27.47	-24.43	-21.52	-19.05	-18.02	-16.67
	URef2	-25.96	-24.75	-21.38	-17.3	-15.93	-14.3
	URef3	-25.81	-24.69	-22.21	-19.74	-18.5	-17.15
	URef4	-26.91	-25.45	-22.27	-19.77	-18.62	-17.33
	URef5	-26.26	-24.92	-21.32	-17.76		
	Mean	-26.48	-24.84	-21.74	-18.72	-17.76	-16.36
	StdDev	0.69	0.37	0.46	1.13	1.25	1.40

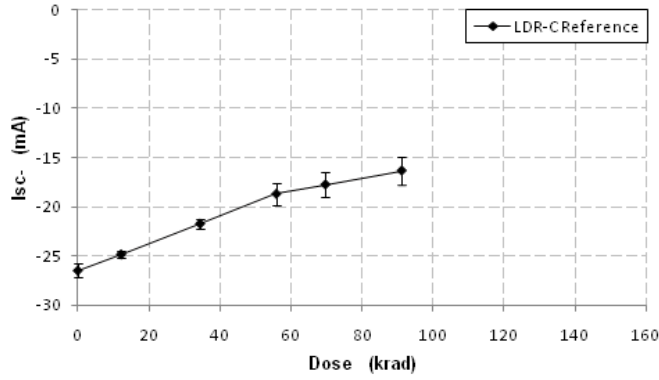

Raw Data	Device Type: HS-OP470ARH		Parameter: SR (V/μsec)		Biasing Condition: Unbiased		
LDR-C Reference	Dose (krad)	0.00	12.16	34.37	55.80	69.59	91.03
	URef1	2.06	2.08	2.08	1.90	1.90	1.86
	URef2	2.08	2.08	1.96	1.88	1.88	1.86
	URef3	2.19	2.12	1.96	1.88	1.88	1.81
	URef4	2.10	2	1.96	1.96	1.96	1.73
	URef5	2.04	2.12	1.94	1.94	1.94	1.73
	Mean	2.09	2.08	1.98	1.91	1.91	1.80
	StdDev	6.08E-02	5.22E-02	0.05	3.35E-02	3.35E-02	6.10E-02

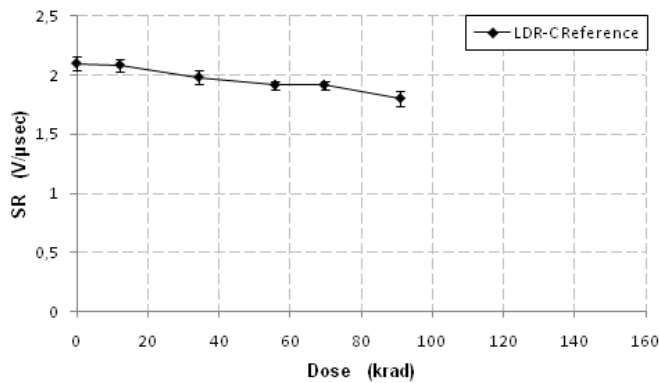

Contact

AIT Austrian Institute of Technology GmbH
Donau-City-Straße 1, 1220 Wien, Austria

www.ait.ac.at
Fax +43 (0) 50550-2201

Dr. Peter Beck
Nanodosimetry
+43 (0) 50550-4305
hubert.brückl@ait.ac.at

Mag. Dr. Susanne Kiefer
Marketing
+43 (0) 50550-3579
susanne.kiefer@ait.ac.at

Mag. Shweta Kumar
Sekretary
+43 (0) 50550-4300
Kerstin.formanek@ait.ac.at