

## R E P O R T

# LM324AN – Low Dose Rate Testing @ 36 rad h<sup>-1</sup> ESTEC - Contract No. 22051/08/NL/PA

Project Coordinator: Peter Beck

Project Team: Michael Wind  
Marcin Latocha

ESA Technical Project Officer: Marc Poizat

# 1 Document Approval Sheet

Document title:	LM324AN – Low Dose Rate Testing @ 36 rad h <sup>-1</sup>
Document number:	1_ELDRS_AIT_LDR-C_LM324AN_vers1.0.docx
Issue:	1
Revision:	0

Prepared by:	
	Name: Michael Wind
Released by:	
	Name: Peter Beck
Approved by:	
	Name: Marc Poizat

## 2 Document Change Record

<b>Issue/ Revision</b>	<b>Date</b>	<b>Affected section</b>	<b>Description</b>
1/0	01/12/2011	All	First issue

### 3 Distribution List

Institution		Copies
AIT	Dr. Peter Beck	1
	Dr. Michael Wind	1
	DI Marcin Latocha	1
ESA	Dr. Marc Poizat	1
	Dr. Ali Zadeh	1

This is a controlled document. Changes and revisions will be issued, as they are approved, to holders of this document.

## 4 Content

1	Document Approval Sheet .....	2
2	Document Change Record .....	3
3	Distribution List .....	4
4	Content .....	5
5	List of Abbreviations .....	6
6	Scope and Objectives .....	7
7	General Overview of the Measurements .....	8
8	DUT properties and Sample Enumeration .....	9
9	Biasing Conditions .....	10
10	Exposure Plan for Low Dose Rate Testing and Cumulative Dose Levels .....	10
11	Measured Low Dose Rate Data .....	11
12	Test Plan – Summary .....	12
13	References .....	13
Annex A:	Reference data obtained with the LM324AN microcircuit .....	14

## 5 List of Abbreviations

AIT	Austrian Institute of Technology
CMRR	Common Mode Rejection Ratio
CNS	Centre National d'Études Spatiales
CTB	Component Technological Board
CTR	Current Transfer Ratio
DIL	Dual In Line
DEL	Dosimetry Eichlabor (Dosimetry Laboratory)
DUT	Device Under Test
EEE	Electrical Electronic Electromechanical
ELDRS	Enhanced Low Dose Rate Sensitivity
ESA	European Space Agency
ESCC	European Space Component Coordination
ESTEC	European Space Research and Technology Centre
HDR	High Dose Rate
HDR-S	High Dose Rate – exposure of the switching experiment
HZL	Hot Cell Laboratory
IC	Integrated Circuit
LDR	Low Dose Rate
LDR-C	Low Dose Rate – Continuous exposure
LDR-S	Low Dose Rate – exposure of the switching experiment
LET	Linear Energy Transfer
NES	Nuclear Engineering Seibersdorf GmbH
OTA	Operational Transconductance Amplifier
PCB	Printed Circuit Board
PSRR	Power Supply Rejection Ratio
RD	Reference Document
RWG	Radiation Working Group
SCADUS	Smart Control and Development Universal Software
SOW	Statement Of Work
SR	Slew Rate
TID	Total Ionizing Dose
TRR	Test Readiness Review
TN	Technical Note
VEE	Visual Engineering Environment
WO	Work Order
WP	Work Package

## 6 Scope and Objectives

This report journalizes low dose rate measurements conducted with the LM324AN microcircuit at a dose rate of  $36 \text{ rad}_{(Si)} \text{ h}^{-1}$ . Results obtained from these measurements serve as a reference for an experiment that is investigating the accelerated switching test method (see [BOC04], [BOC05], [DUS08], and [BOC09]). The low dose rate degradation is measured for an extensive set of parameters.

This report serves as measurement protocol and a detailed reference data collection. In detail this report includes:

- General overview of the measurements
- Information on DUT properties (e.g. manufacturer, date code, lot ID)
- Enumeration of the DUTs (naming conventions) during the experiments
- Exposure plan
- Dose levels received by each DUT during the exposure
- Measured low dose rate data for each unit and each characterized parameter

## 7 General Overview of the Measurements

The low dose rate exposure is using a constant dose rate Co-60 photon field with a dose rate of approximately  $10 \text{ mrad}_{(Si)} \text{ s}^{-1}$ . The exposure is only interrupted for characterisation of the DUTs, which are performed on average every three to four weeks. In terms of total dose this means that a characterisation is done approximately every  $20 \text{ krad}_{(Si)}$ . 115 days of continuous exposure are needed to reach the specified total dose level of  $100 \text{ krad}_{(Si)}$ .

All units are mounted on one PCB that is presented in Figure 1. It is noted that this PCB is used also for other experiments that are carried out in parallel. Biased units are positioned in the centre of the board. They are arranged in columns of five units, in each column the biased units of one device type is mounted. To the left and to the right the unbiased units are mounted on antistatic foam that is enwrapped in aluminium. This ensures that all pins are grounded. The pin to ground resistance is typical less than  $4 \Omega$ . A RadFET dosimeter is used to monitor the dose received by the DUTs.

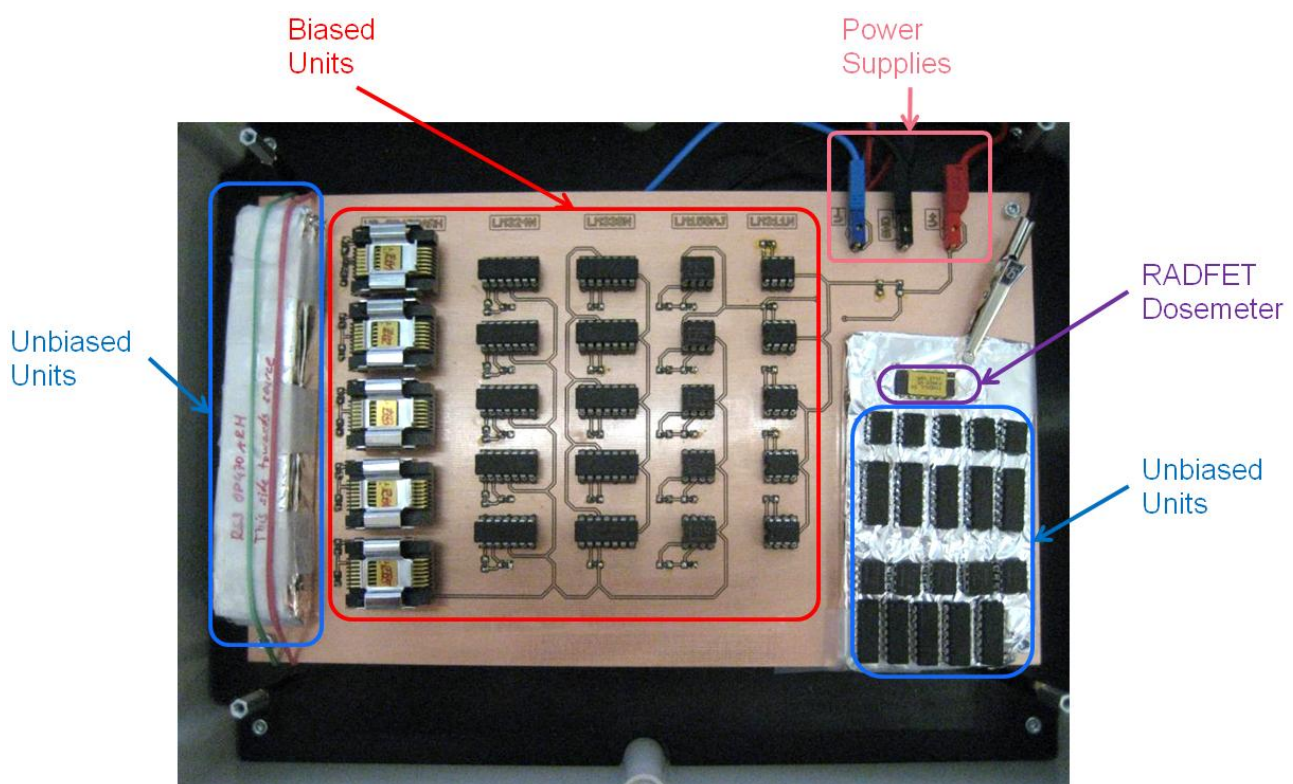

Figure 1: Printed circuit board housing all the biased and unbiased units used for the reference measurements during exposure.

The Co-60 source used for the exposure has an activity of  $16.41 \text{ Ci}$  ( $607 \text{ GBq}$ ); the source is mounted in a portable housing that is a gamma ray radiography camera, i.e. in a Gammamat TK-30. The required dose rate of  $10 \text{ mrad}_{(Si)} \text{ s}^{-1}$  is available at a distance of approximately  $70 \text{ cm}$  from the point source.

The source is kept in a shielding made from depleted Uranium encircled by a stainless steel housing. The source can be moved in and out from the shielding via a locating channel. The source is turned off when it is completely retracted and the Uranium shutter is closed. For exposure the shutter is opened and the source is moved within the locating channel into a defined position. The result is a defined radiation field with the shape of a cone. The field will be adjusted in such a way, that it is sufficiently large to irradiate three irradiation boards in parallel. A picture of the setting is shown in Figure 2.



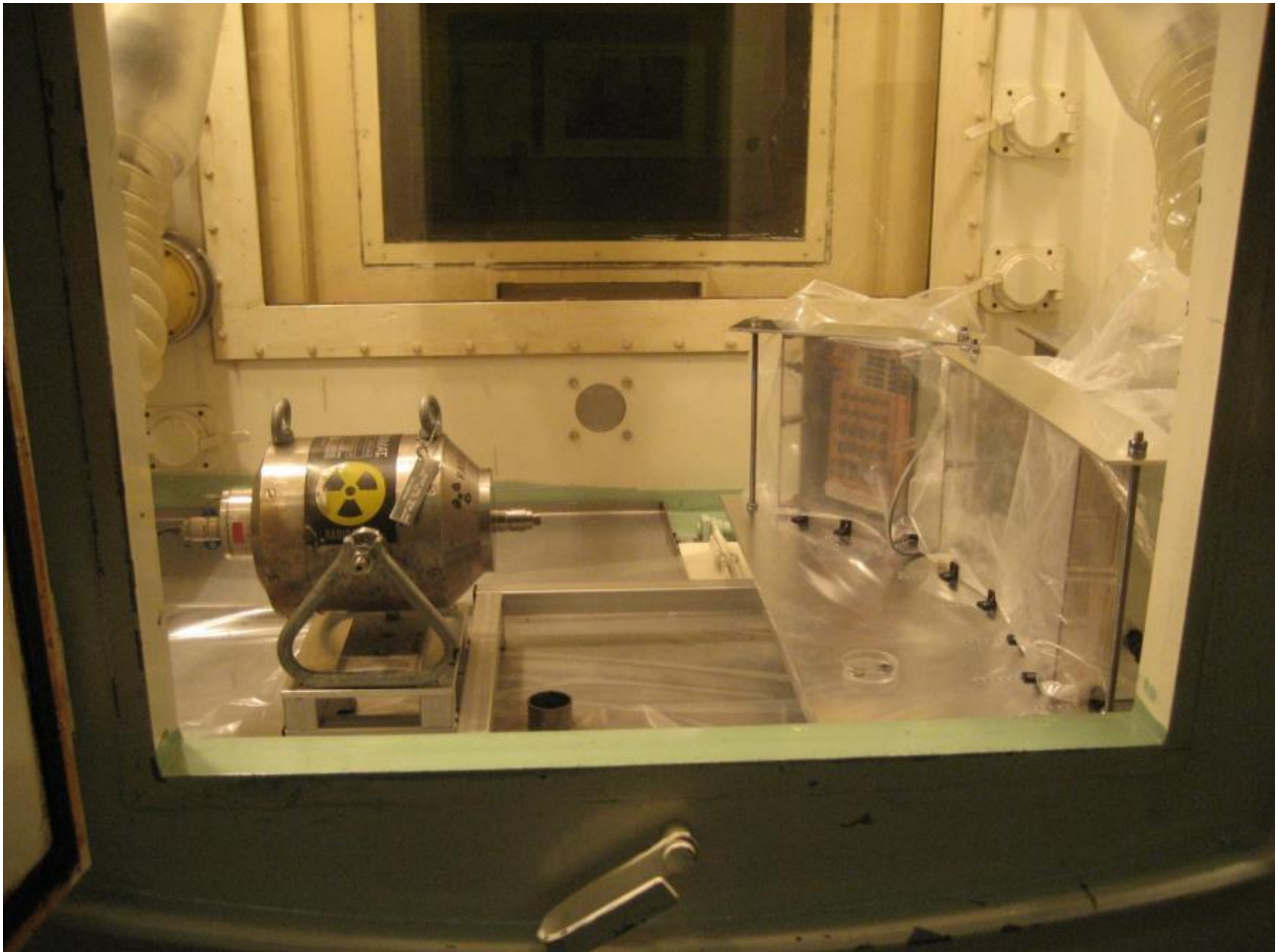

Figure 2: Low dose rate facility; on the left side the radiography camera is positioned, on the right side up to three boxes can be mounted that house one PCB each. The PCB used for the experiments reported here is mounted in the leftmost box.

## 8 DUT properties and Sample Enumeration

Ten units of the LM324AN microcircuit are used for the low dose rate exposure; five units are exposed in biased condition and another five units are exposed in unbiased condition (see Section 9). Some basic device properties are presented in Table 1.

Table 1: Manufacturer, data code, and lot of the units used for reference exposure

Device Type	Manufacturer	D/C	LOT
LM324AN	National Semiconductor	C0912AB	CZ8P1667D019

The units used for the low dose rate exposures are divided in two groups five units each. One group is exposed in biased condition, the other group in unbiased condition. All the five samples of either group are treated identically. Enumeration of the samples is shown in Table 2.

Table 2: Enumeration of the samples

Exposure Series / Dose Rate	Biasing Condition	Enumeration
Low Dose Rate / 36 rad <sub>(Si)</sub> h <sup>-1</sup>	biased	BRef1, BRef2, BRef3, BRef4, BRef5
	unbiased	URef1, URef2, URef3, URef4, URef5

## 9 Biasing Conditions

Tests are conducted in biased and unbiased configuration. In the unbiased configuration all terminals of the microcircuits are held at ground potential. When using biased condition the microcircuits are driven under typical operational conditions. The test circuitry used for the experiments is described in the following.

### 9.1 Unbiased Configuration

The pins of the microcircuit are held at ground potential during the exposure to the ionizing radiation. Hereby they are mounted in antistatic foam that is enwrapped in aluminium foil. The foil itself is connected to ground potential. The pin to ground resistance is typical well below a few Ohms.

### 9.2 Biased Configuration

The LM324AN microcircuit is an operational amplifier that is biased in a non inverting DC gain configuration. Dual voltage supply is used; the positive and negative supply voltages are kept large at  $\pm 15V$ . The loop gain of the circuit is small enough not to drive the amplifier into saturation.  $V_{in}$  is set to to 0.5V, the loop gain is roughly 10 (for details see section 12).

## 10 Exposure Plan for Low Dose Rate Testing and Cumulative Dose Levels

The low dose rate applied to all units during the low dose rate exposure is 10 mrad<sub>(Si)</sub> s<sup>-1</sup>. The exposures are performed in steps of approximately 20 krad<sub>(Si)</sub>. In between two of such steps the DUTs are removed from the facility and transferred to the lab. An extensive parametric device characterisation is performed to investigate the low dose rate radiation response of the DUTs. After characterisation all the units are remounted in the irradiation facility and the exposure is continued.

Table 3 presents a time table of all exposure steps and the length of the breaks, during which parametric device characterization is done. The cumulative dose to which the DUTs were exposed (at the end of each exposure setup) is presented in the rightmost column.

Table 3: Time table of the low dose rate exposure steps and cumulative dose levels to which the DUTs have been exposed.

Action #	Date	Exposure Stop	Exposure Resume	Duration of Interruption	Cumulative Dose Level
1	12 <sup>th</sup> December 2010	-----	16:00	-----	0.00 krad <sub>(Si)</sub>
2	22 <sup>nd</sup> December 2010	13:25	15:45	2:20	12.17 krad <sub>(Si)</sub>
3	12 <sup>th</sup> January 2011	13:00	16:00	3:00	28.19 krad <sub>(Si)</sub>
4	20 <sup>th</sup> January 2011	13:15	16:00	2:45	34.18 krad <sub>(Si)</sub>
5	17 <sup>th</sup> February 2011	13:00	16:05	3:05	55.61 krad <sub>(Si)</sub>
6	4 <sup>th</sup> April 2011	10:00	-----	-----	90.10 krad <sub>(Si)</sub>

## 11 Measured Low Dose Rate Data



The parametric device degradation of all units is measured with a parameter analyzer. Measurement Data are presented as parameter value vs. dose (in units of  $\text{krad}_{(Si)}$ ) for all parameters presented in Table 4. Data are presented as tabled values as well as in plots. For each device type and biasing condition five units are irradiated under identical conditions. The tabled data present the results of all five units as well as average values and the standard deviations. In the plots only the average values are presented. Uncertainty bars are calculated as the standard deviation.

The reference data obtained for LM324AN microcircuit is presented in Annex A: Reference data obtained with the LM324AN microcircuit.

Table 4: Parametes measured

<b>Electric Parameter used for the characterization of the low dose rate degradation</b>	<b>Symbol</b>
Offset Voltage	$V_{OS}$
Positive Supply Current	$I_{S+}$
Negative Supply Current	$I_{S-}$
Input Bias Current at the Non Inverting Input	$I_{b+}$
Input Bias Current at the Inverting Input	$I_{b-}$
Input Bias Current	$I_b$
Input Offset Current	$I_{OS}$
Open Loop Gain	$A_{VO}$
Common Mode Rejection Ration	CMRR
Positive Power Supply Rejection Ratio	PSRR
Negative Power Supply Rejection Ratio	PSRR-
Positive Output Voltage Swing	$V_{O+}$
Negative Output Voltage Swing	$V_{O-}$
Positive Short Circuit Current	$I_{SC+}$
Negative Short Circuit Current	$I_{SC-}$
Slew Rate	SR

## 12 Test Plan – Summary

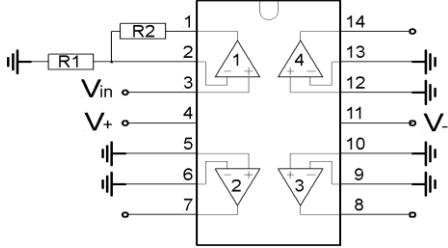
				<b>Total Dose Test Report For:</b> LM324AN	
<b>Family:</b> Operational Amplifier  <b>Package:</b> DIL		<b>Lot Code:</b> CZ8P1667D019  <b>Manufacturing Date Code:</b> C0912AB		<b>Manufacturer:</b> National Semiconductor  <b>Contact Person:</b> Kirby Kruckmeyer  <b>Address:</b> 2900 Semiconductor Drive, Santa Clara, California, USA	
<b>Test Facility Name:</b> Nuclear Engineering Seibersdorf GesmbH  <b>Address:</b> Forschungszentrum Seibersdorf, Seibersdorf, A-2444		<b>Irradiation Test Plan:</b>  <b>No.:</b> AIT-3 <b>Iss.:</b> 1 <b>Rev.:</b> 0			
<b>Irradiation Conditions:</b> Biased (In-Situ) & Unbiased  <b>Electrical Measurement:</b>  <b>Parameters Tested:</b> $V_{OS}$ , $I_{S+}$ , $I_{S-}$ , $I_{b+}$ , $I_{b-}$ , $I_b$ , $I_{OS}$ , $A_{VO}$ , CMRR, PSRR, PSRR-, $V_{O+}$ , $V_{O-}$ , $I_{SC+}$ , $I_{SC-}$ , SR Temp: 26 °C		<b>Biased Configuration:</b>  <b>Supply Voltages:</b> $V_{\pm}$ : $\pm 15V$  $V_{in}$ : 0.5V  <b>Resistors:</b> $R_1$ : 1k $\Omega$ , $R_2$ : 9.1k $\Omega$		<b>Schematic of Test Circuitry:</b> 	
<b>Facilities:</b> Hot Cell Laboratory of the Nuclear Engineering Seibersdorf GesmbH		<b>Source:</b> gamma <b>Energy:</b> Co-60 (1.17 MeV, 1.33MeV) <b>Dose Rate:</b> 8.94 mrad <sub>(SI)</sub> s <sup>-1</sup>		<b>Absorber Material:</b> PMMA <b>Thickness:</b> 3mm <b>Duration:</b> 129.5 d	
<b>Anneal Test:</b> No					
<b>Irradiation Sequence</b>					
<b>Step No.</b>	<b>Description</b>	<b>Begin</b>	<b>End</b>	<b>Exposure Time</b>	
1	Long term exposure Exposure is interrupted several times for ~2 hours for characterization of the electrical parameters. Electrical characterization is done at dose levels of: 12.2, 28.2, 34.2, 55.6, and 90.1 krad <sub>(SI)</sub>	7 <sup>th</sup> Dec 2010	4 <sup>th</sup> April 2011	118 d	
<b>Irradiation Test Facility: Responsible</b>  <b>Name:</b> Michael Wind  <b>Telephone:</b> +43 (0) 50550 - 4310			<b>Electrical Test: Responsible</b>  <b>Name:</b> Michael Wind  <b>Telephone:</b> +43 (0) 50550 - 4310		

## 13 References

- BOC04 J. Boch, F. Saigné, R.D. Schrimpf, D.M. Fleetwood, S. Ducret, L. Dusseau, J.P., David, J. Fesquet, J. Gasiot, R. Ecoffet, Effect of Switching From High to Low Dose Rate on Linear Bipolar Technology Radiation Response, IEEE-TNS, vol.51(5), p.2896, October 2004
- BOC05 J. Boch, F. Saigné, R.D. Schrimpf, J.-R. Vaillé, L. Dusseau, S. Ducret, M. Bernard, E. Lorfèvre, and C. Chatry, Estimation of Low-Dose-Rate Degradation on Bipolar Linear Integrated Circuits Using Switching Experiments, IEEE-TNS, vol. 52 (6), p. 2616, December 2005
- BOC09 J. Boch, Y. Gonzalez Velo, F. Saigné, N. J-H. Roche, R.D. Schrimpf, J.-R. Vaillé, L. Dusseau, C. Chatry, E. Lorfèvre, R. Ecoffet, A.D. Touboul, The use of a Dose- Rate Switching Technique to Characterize Bipolar Devices, submitted to IEEE-TNS, accepted for NSREC, 2009
- DUS08 L. Dusseau, M. Bernard, J. Boch, Y. Gonzalez velo, N. Roche, E. Lorfèvre, F. Bezerra, P. Calvel, R. Marec, F. Saigné, Review and Analysis of the Radiation - Induced Degradation Observed for the Input Bias Current of Linear Integrated Circuits, IEEE-TNS, vol. 55 (6), p.3174, December 2008
- NAT00 National Semiconductor Corporation, LM124/LM224/LM324/LM2902 Low Power Quad Operational Amplifiers, datasheet, August 2000

## Annex A: Reference data obtained with the LM324AN microcircuit

Raw Data	Device Type: LM324AN	Parameter: Vos (mV)	Biasing Condition: Biased				
LDR-C Reference	Dose (krad)	0.00	12.16	28.19	34.17	55.61	90.95
	BRef1	-1.53	-3.04	-5.53	-6.16	-7.11	-7.16
	BRef2	-1.01	-2.66	-5.22	-5.86	-6.80	-6.70
	BRef3	-1.21	-2.91	-5.46	-5.98	-6.95	-6.86
	BRef4						
	BRef5	-1.00	-2.48	-4.89	-5.48	-6.49	-6.60
	Mean	-1.18	-2.77	-5.27	-5.87	-6.84	-6.83
	StdDev	0.24	0.24	0.29	0.29	0.26	0.24

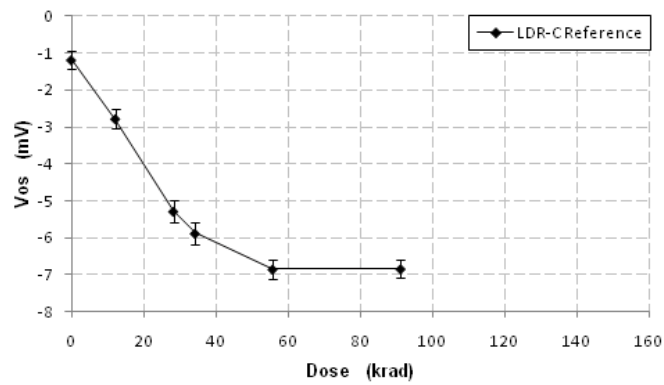

Raw Data	Device Type: LM324AN	Parameter: Is+ (mA)	Biasing Condition: Biased				
LDR-C Reference	Dose (krad)	0.00	12.16	28.19	34.17	55.61	90.95
	BRef1	0.73	0.61	0.56	0.56	0.57	0.59
	BRef2	0.72	0.61	0.56	0.56	0.56	0.59
	BRef3	0.73	0.61	0.56	0.56	0.57	0.59
	BRef4						
	BRef5	0.74	0.63	0.58	0.58	0.58	0.61
	Mean	0.73	0.62	0.57	0.56	0.57	0.60
	StdDev	9.83E-03	1.18E-02	9.73E-03	8.86E-03	8.05E-03	7.12E-03

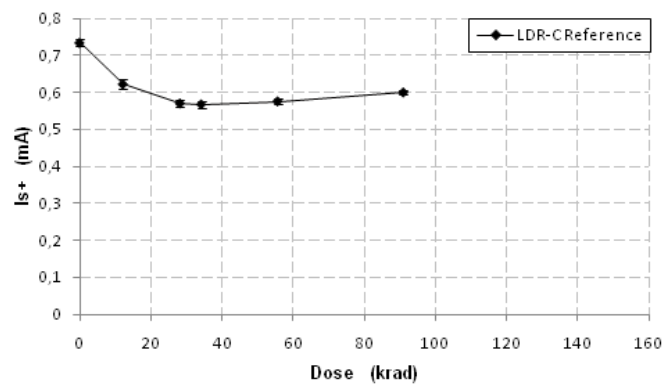

Raw Data	Device Type: LM324AN	Parameter: Is- (mA)	Biasing Condition: Biased				
LDR-C Reference	Dose (krad)	0.00	12.16	28.19	34.17	55.61	90.95
	BRef1	-0.81	-0.68	-0.64	-0.62	-0.65	-0.66
	BRef2	-0.80	-0.67	-0.63	-0.62	-0.64	-0.65
	BRef3	-0.80	-0.68	-0.64	-0.62	-0.65	-0.66
	BRef4						
	BRef5	-0.82	-0.70	-0.66	-0.64	-0.66	-0.67
	Mean	-0.81	-0.68	-0.64	-0.63	-0.65	-0.66
	StdDev	9.51E-03	1.13E-02	9.40E-03	8.93E-03	7.66E-03	6.94E-03

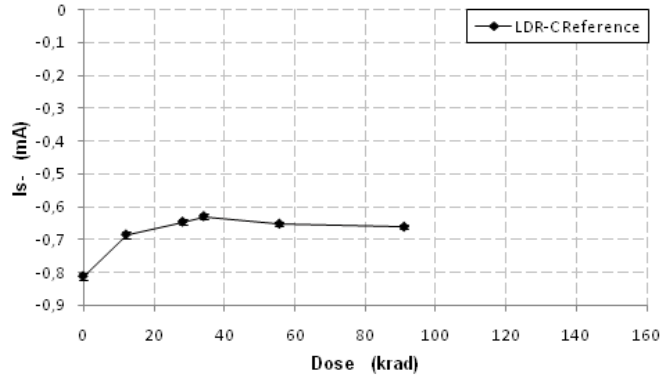

Raw Data	Device Type: LM324AN	Parameter: Ib+ (uA)	Biasing Condition: Biased				
LDR-C Reference	Dose (krad)	0.00	12.16	28.19	34.17	55.61	90.95
	BRef1	-0.01	-0.22	-0.35	-0.36	-0.34	-0.28
	BRef2	-0.01	-0.22	-0.35	-0.36	-0.33	-0.28
	BRef3	-0.01	-0.23	-0.36	-0.37	-0.34	-0.29
	BRef4						
	BRef5	-0.01	-0.20	-0.33	-0.34	-0.34	-0.28
	Mean	-0.01	-0.22	-0.35	-0.36	-0.34	-0.28
	StdDev	5.92E-04	1.12E-02	9.44E-03	1.17E-02	5.07E-03	4.97E-03

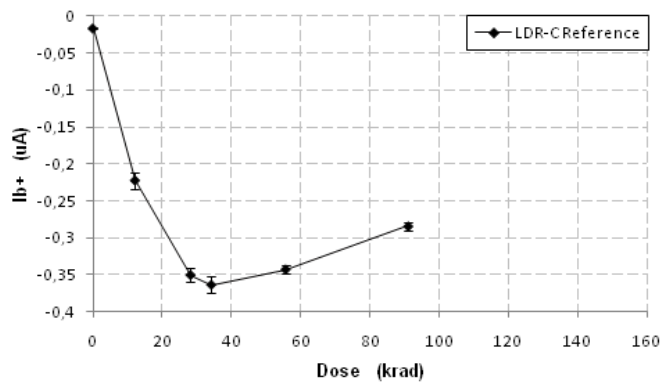

Raw Data	Device Type: LM324AN	Parameter: Ib- (uA)	Biasing Condition: Biased				
LDR-C Reference	Dose (krad)	0.00	12.16	28.19	34.17	55.61	90.95
	BRef1	-0.01	-0.22	-0.33	-0.35	-0.34	-0.28
	BRef2	-0.01	-0.22	-0.34	-0.35	-0.33	-0.27
	BRef3	-0.01	-0.21	-0.34	-0.34	-0.33	-0.27
	BRef4						
	BRef5	-0.01	-0.20	-0.31	-0.33	-0.31	-0.28
	Mean	-0.01	-0.21	-0.33	-0.34	-0.33	-0.27
	StdDev	8.55E-04	1.01E-02	1.18E-02	8.89E-03	1.04E-02	2.67E-03

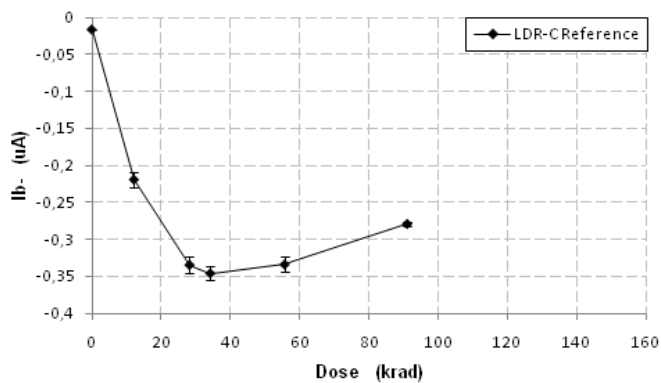

Raw Data	Device Type: LM324AN	Parameter: Ib (uA)	Biasing Condition: Biased				
LDR-C Reference	Dose (krad)	0.00	12.16	28.19	34.17	55.61	90.95
	BRef1	-0.01	-0.22	-0.34	-0.35	-0.34	-0.28
	BRef2	-0.01	-0.22	-0.34	-0.35	-0.33	-0.28
	BRef3	-0.01	-0.22	-0.35	-0.36	-0.34	-0.28
	BRef4						
	BRef5	-0.01	-0.20	-0.32	-0.34	-0.33	-0.28
	Mean	-0.01	-0.22	-0.34	-0.35	-0.33	-0.28
	StdDev	7.19E-04	9.81E-03	1.03E-02	9.64E-03	4.98E-03	1.44E-03

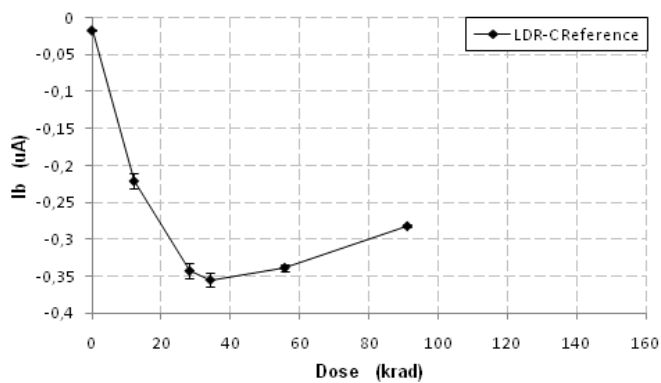



Raw Data	Device Type: LM324AN	Parameter: Ios (uA)	Biasing Condition: Biased				
LDR-C Reference	Dose (krad)	0.00	12.16	28.19	34.17	55.61	90.95
	BRef1	-0.00	-0.00	-0.00	-0.01	-0.00	-0.00
	BRef2	-0.00	0.00	-0.00	-0.00	-0.00	-0.00
	BRef3	-0.00	-0.01	-0.01	-0.02	-0.01	-0.00
	BRef4						
	BRef5	0.00	-0.00	-0.00	-0.00	-0.01	-0.00
	Mean	-0.00	-0.00	-0.00	-0.01	-0.00	-0.00
	StdDev	1.48E-04	6.13E-03	3.87E-03	5.32E-03	6.54E-03	0.00

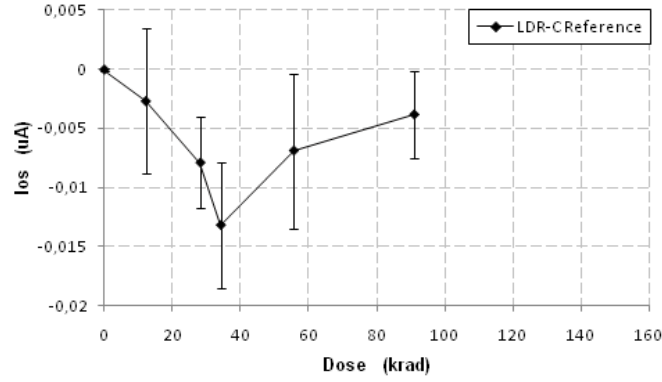

Raw Data	Device Type: LM324AN	Parameter: Avo (dB)	Biasing Condition: Biased				
LDR-C Reference	Dose (krad)	0.00	12.16	28.19	34.17	55.61	90.95
	BRef1	114	100.8	86.58	89.34	88.33	90.58
	BRef2	113.6	100.7	86.67	89.97	88.84	90.91
	BRef3	114.4	100.7	86.63	89.41	88.89	90.82
	BRef4						
	BRef5	115.4	102	88.86	91.53	90.21	91.76
	Mean	114.35	101.05	87.18	90.06	89.06	91.01
	StdDev	0.77	0.63	1.11	1.01	0.80	0.51

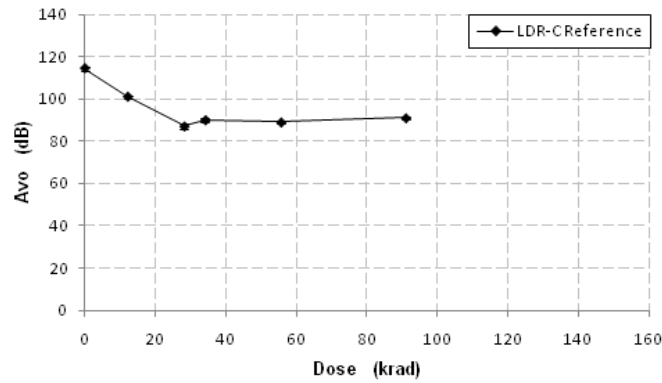

Raw Data	Device Type: LM324AN	Parameter: CMRR (dB)	Biasing Condition: Biased				
LDR-C Reference	Dose (krad)	0.00	12.16	28.19	34.17	55.61	90.95
	BRef1	98.73	97.55	104.9	90.55	90.01	92.87
	BRef2	100.1	98.32	104.1	91.33	91.15	93.76
	BRef3	98.14	96.54	109	90.4	89.82	91.93
	BRef4						
	BRef5	97.52	96.59	116.2	91.6	91.38	93.04
	Mean	98.62	97.25	108.55	90.97	90.59	92.9
	StdDev	1.10	0.85	5.53	0.58	0.78	0.75

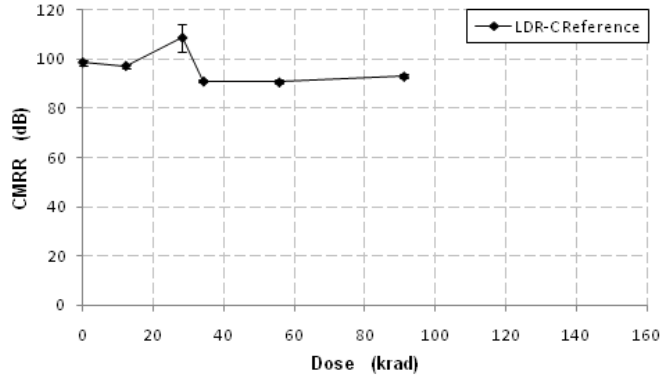

Raw Data	Device Type: LM324AN	Parameter: PSRR (dB)	Biasing Condition: Biased				
LDR-C Reference	Dose (krad)	0.00	12.16	28.19	34.17	55.61	90.95
	BRef1	104	97	78.19	83.09	80.97	81.93
	BRef2	98.61	93.01	77.7	82.17	80.49	81.18
	BRef3	103.3	94.89	78.01	83.01	80.79	81.74
	BRef4						
	BRef5	102.9	95.4	78.84	83.47	80.91	81.32
	Mean	102.20	95.07	78.18	82.93	80.79	81.54
	StdDev	2.43	1.64	0.48	0.54	0.21	0.35

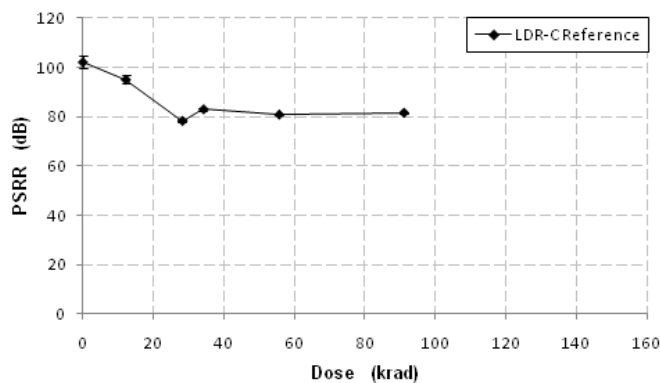

Raw Data	Device Type: LM324AN	Parameter: PSSR- (dB)	Biasing Condition: Biased				
LDR-C Reference	Dose (krad)	0.00	12.16	28.19	34.17	55.61	90.95
	BRef1	103.1	102.6	88.35	91.37	89.79	91.66
	BRef2	102.7	101.4	87.89	90.77	89.31	90.75
	BRef3	103.2	100.7	87.66	91.46	89.2	91.1
	BRef4						
	BRef5	102.5	99.84	87.26	91.26	89.48	90.59
	Mean	102.87	101.13	87.79	91.21	89.44	91.02
	StdDev	0.33	1.16	0.45	0.30	0.25	0.47

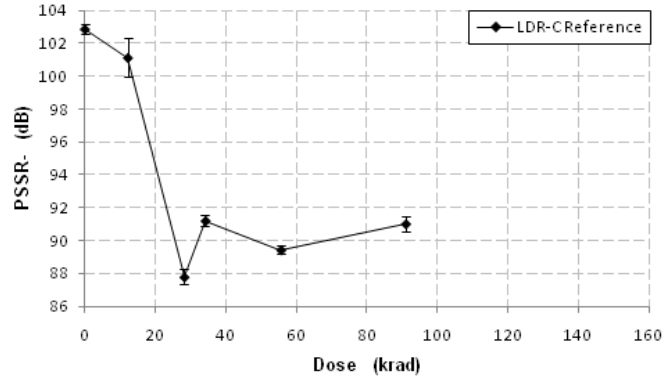

Raw Data	Device Type: LM324AN	Parameter: Vo+ (V)	Biasing Condition: Biased				
LDR-C Reference	Dose (krad)	0.00	12.16	28.19	34.17	55.61	90.95
	BRef1	13.79	13.81	13.82	13.8	13.8	13.79
	BRef2	13.79	13.81	13.82	13.8	13.8	13.79
	BRef3	13.79	13.81	13.82	13.8	13.8	13.79
	BRef4						
	BRef5	13.8	13.81	13.82	13.81	13.8	13.79
	Mean	13.79	13.81	13.82	13.80	13.8	13.79
	StdDev	5.00E-03	0.00	0.00	4.99E-03	0.00	0.00

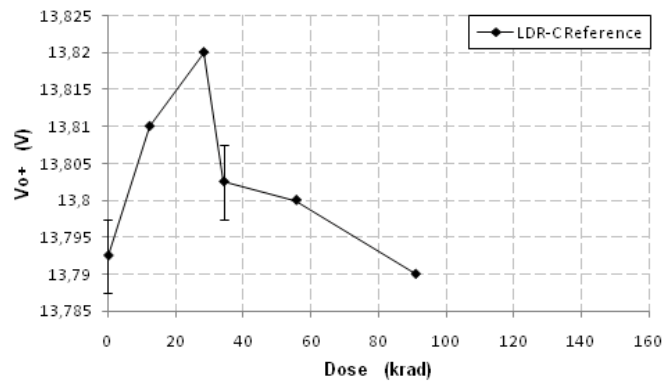

Raw Data		Device Type: LM324AN		Parameter: Vo- (V)		Biasing Condition: Biased	
LDR-C Reference	Dose (krad)	0.00	12.16	28.19	34.17	55.61	90.95
	BRef1	-14.97	-14.96	-14.94	-14.94	-14.95	-14.94
	BRef2	-14.96	-14.95	-14.95	-14.94	-14.95	-14.94
	BRef3	-14.97	-14.95	-14.95	-14.94	-14.95	-14.94
	BRef4						
	BRef5	-14.96	-14.95	-14.95	-14.95	-14.95	-14.94
	Mean	-14.96	-14.95	-14.94	-14.94	-14.95	-14.94
	StdDev	5.77E-03	5.00E-03	4.99E-03	4.99E-03	0.00	0.00

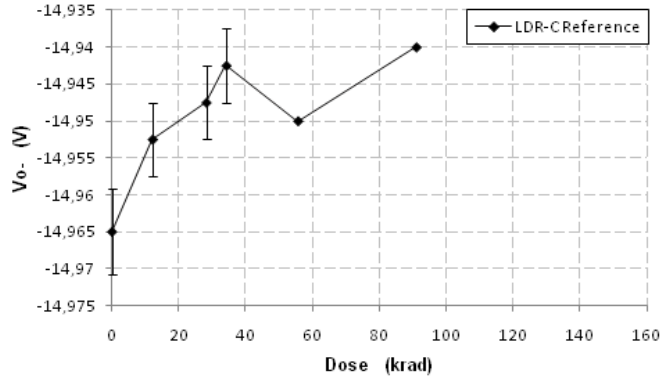

Raw Data		Device Type: LM324AN		Parameter: Isc+ (mA)		Biasing Condition: Biased	
LDR-C Reference	Dose (krad)	0.00	12.16	28.19	34.17	55.61	90.95
	BRef1	42.79	42.11	41.84	41.98	42.02	41.88
	BRef2	42.87	42.14	41.87	42.11	42.03	41.92
	BRef3	42.61	41.9	41.58	41.89	41.81	41.67
	BRef4						
	BRef5	42.91	42.21	41.89	42.2	42.1	41.98
	Mean	42.79	42.09	41.79	42.04	41.99	41.86
	StdDev	0.13	0.13	0.14	0.13	0.12	0.13

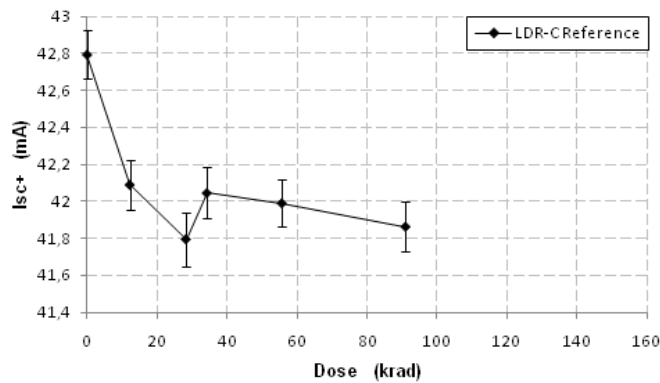

Raw Data — Device Type: LM324AN Parameter: Isc- (mA) Biasing Condition: Biased

LDR-C Reference	Dose (krad)	0.00	12.16	28.19	34.17	55.61	90.95
	BRef1	-32.8	-25.12	-20.67	-20.07	-19.08	-19.23
	BRef2	-32.87	-25.13	-20.74	-20.23	-19.17	-19.41
	BRef3	-32.82	-25.22	-20.7	-20.29	-19.25	-19.41
	BRef4						
	BRef5	-34.4	-27.23	-22.73	-22.14	-20.89	-20.84
	Mean	-33.22	-25.67	-21.21	-20.68	-19.59	-19.72
	StdDev	0.78	1.03	1.01	0.97	0.86	0.74

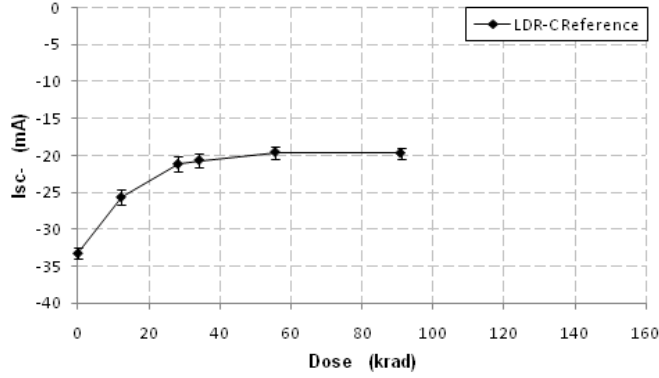

Raw Data — Device Type: LM324AN Parameter: SR (V/μsec) Biasing Condition: Biased

LDR-C Reference	Dose (krad)	0.00	12.16	28.19	34.17	55.61	90.95
	BRef1	0.29	0.19	0.15	0.14	0.15	0.16
	BRef2	0.29	0.2	0.15	0.14	0.15	0.17
	BRef3	0.29	0.2	0.14	0.14	0.15	0.16
	BRef4						
	BRef5	0.29	0.21	0.15	0.16	0.16	0.17
	Mean	0.29	0.20	0.15	0.14	0.15	0.17
	StdDev	3.30E-03	7.39E-03	4.85E-03	7.89E-03	5.47E-03	6.40E-03

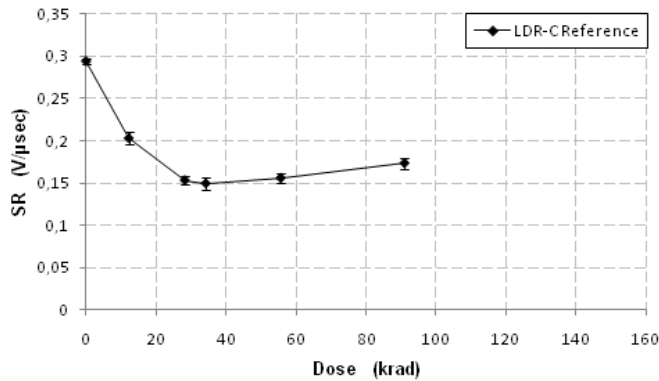

Raw Data — Device Type: LM324AN Parameter: Vos (mV) Biasing Condition: Unbiased

LDR-C Reference	Dose (krad)	0.00	12.16	28.19	34.17	55.61	90.95
	BRef1	-1.75	-5.47	-15.88	-20.82	-37.64	-61.97
	BRef2	-1.08	-4.63	-14.85	-19.46	-36.95	-59.34
	BRef3	-1.55	-4.68	-13.77	-18.04	-33.39	-52.68
	BRef4	-1.73	-5.21	-15.59	-20.65	-37.83	-60.96
	BRef5	-1.34	-4.65	-14.99	-19.85	-36.79	-60.56
	Mean	-1.49	-4.93	-15.01	-19.76	-36.52	-59.10
	StdDev	0.28	0.38	0.81	1.11	1.80	3.71

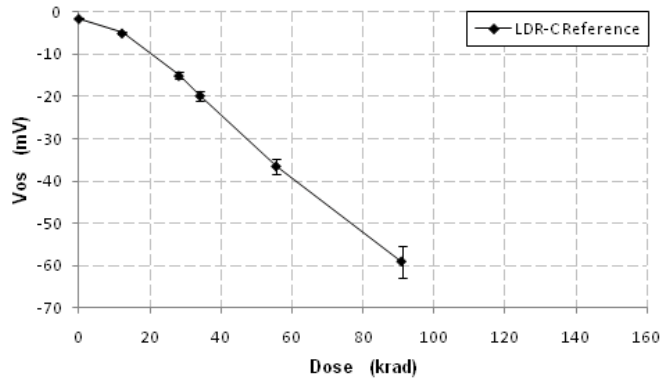

Raw Data — Device Type: LM324AN Parameter: Is+ (mA) Biasing Condition: Unbiased

LDR-C Reference	Dose (krad)	0.00	12.16	28.19	34.17	55.61	90.95
	BRef1	0.73	0.57	0.46	0.45	0.42	0.40
	BRef2	0.74	0.57	0.47	0.45	0.42	0.40
	BRef3	0.75	0.58	0.48	0.46	0.43	0.41
	BRef4	0.73	0.56	0.46	0.44	0.41	0.39
	BRef5	0.73	0.56	0.46	0.45	0.41	0.40
	Mean	0.73	0.57	0.47	0.45	0.42	0.40
	StdDev	7.09E-03	9.56E-03	7.31E-03	6.88E-03	5.65E-03	5.33E-03

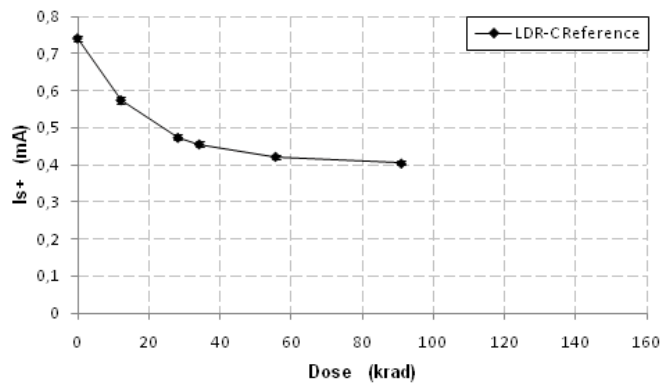

Raw Data — Device Type: LM324AN Parameter: Is- (mA) Biasing Condition: Unbiased

LDR-C Reference	Dose (krad)	0.00	12.16	28.19	34.17	55.61	90.95
	BRef1	-0.81	-0.63	-0.54	-0.51	-0.49	-0.46
	BRef2	-0.82	-0.64	-0.55	-0.52	-0.49	-0.46
	BRef3	-0.82	-0.65	-0.56	-0.52	-0.50	-0.47
	BRef4	-0.81	-0.64	-0.54	-0.51	-0.49	-0.45
	BRef5	-0.81	-0.64	-0.54	-0.51	-0.49	-0.46
	Mean	-0.81	-0.64	-0.54	-0.51	-0.49	-0.46
	StdDev	7.02E-03	6.45E-03	7.22E-03	6.82E-03	6.29E-03	5.35E-03

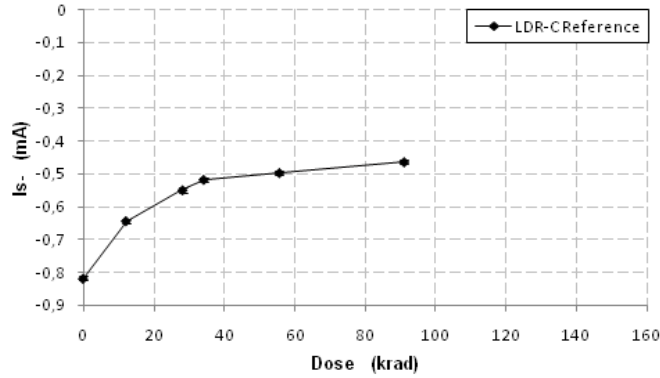

Raw Data — Device Type: LM324AN Parameter: Ib+ (uA) Biasing Condition: Unbiased

LDR-C Reference	Dose (krad)	0.00	12.16	28.19	34.17	55.61	90.95
	BRef1	-0.01	-0.34	-0.53	-0.49	-0.34	-0.08
	BRef2	-0.01	-0.31	-0.45	-0.46	-0.29	0.30
	BRef3	-0.01	-0.31	-0.50	-0.48	-0.32	-0.02
	BRef4	-0.01	-0.33	-0.54	-0.46	-0.32	0.05
	BRef5	-0.01	-0.35	-0.44	-0.49	-0.36	0.08
	Mean	-0.01	-0.33	-0.49	-0.47	-0.33	0.06
	StdDev	3.30E-04	1.89E-02	4.78E-02	1.65E-02	2.53E-02	0.14

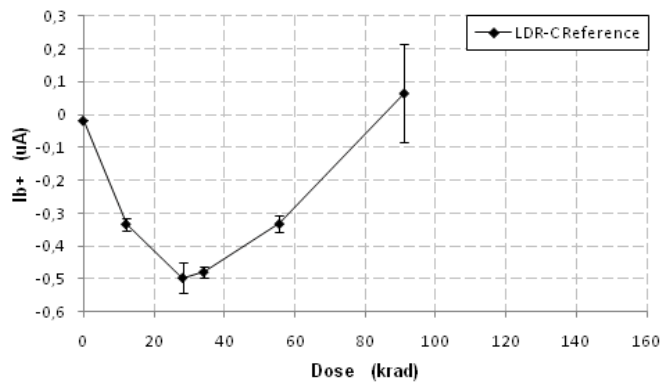

Raw Data — Device Type: LM324AN Parameter: Ib- (uA) Biasing Condition: Unbiased

LDR-C Reference	Dose (krad)	0.00	12.16	28.19	34.17	55.61	90.95
	BRef1	-0.01	-0.27	-0.44	-0.55	-0.86	-1.42
	BRef2	-0.01	-0.29	-0.52	-0.56	-0.94	-1.88
	BRef3	-0.01	-0.27	-0.46	-0.55	-0.92	-1.37
	BRef4	-0.01	-0.30	-0.44	-0.61	-0.94	-1.53
	BRef5	-0.01	-0.28	-0.56	-0.56	-0.87	-1.56
	Mean	-0.01	-0.28	-0.48	-0.57	-0.91	-1.55
	StdDev	4.29E-04	1.23E-02	5.23E-02	2.62E-02	3.99E-02	0.19

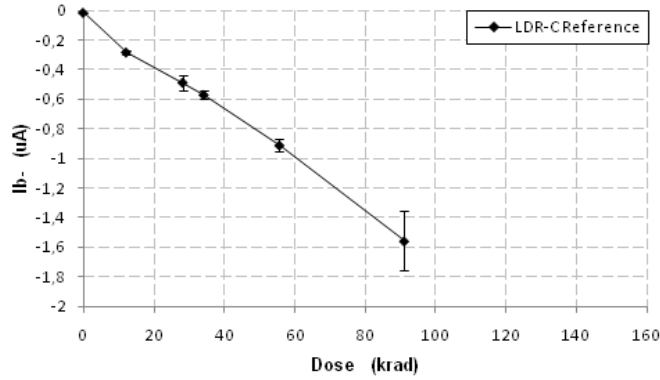

Raw Data — Device Type: LM324AN Parameter: Ib (uA) Biasing Condition: Unbiased

LDR-C Reference	Dose (krad)	0.00	12.16	28.19	34.17	55.61	90.95
	BRef1	-0.01	-0.30	-0.49	-0.52	-0.60	-0.75
	BRef2	-0.01	-0.30	-0.48	-0.51	-0.62	-0.79
	BRef3	-0.01	-0.29	-0.48	-0.51	-0.62	-0.70
	BRef4	-0.01	-0.31	-0.49	-0.53	-0.63	-0.73
	BRef5	-0.01	-0.32	-0.50	-0.52	-0.62	-0.74
	Mean	-0.01	-0.30	-0.49	-0.52	-0.62	-0.74
	StdDev	3.63E-04	1.06E-02	7.76E-03	9.59E-03	1.18E-02	3.16E-02

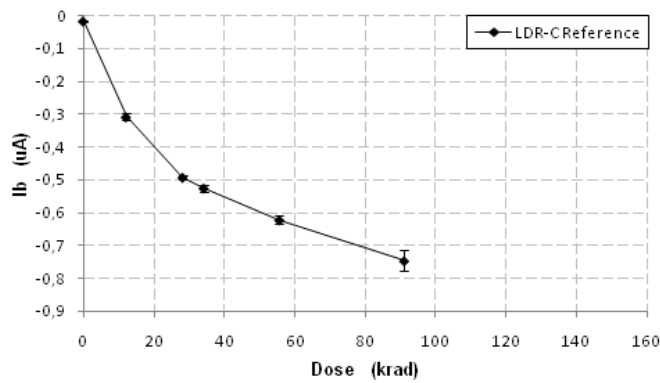



Raw Data		Device Type: LM324AN		Parameter: Ios (uA)		Biasing Condition: Unbiased	
LDR-C Reference	Dose (krad)	0.00	12.16	28.19	34.17	55.61	90.95
	BRef1	0.00	-0.02	-0.00	0.08	0.39	1.32
	BRef2	-0.00	-0.00	0.08	0.11	0.54	1.72
	BRef3	-0.00	-0.02	0.02	0.08	0.48	1.19
	BRef4	0.00	-0.00	-0.00	0.14	0.54	1.35
	BRef5	-0.00	-0.03	0.11	0.09	0.43	1.62
	Mean	-0.00	-0.01	0.04	0.10	0.48	1.44
	StdDev	3.14E-04	1.21E-02	5.59E-02	2.51E-02	6.82E-02	0.22

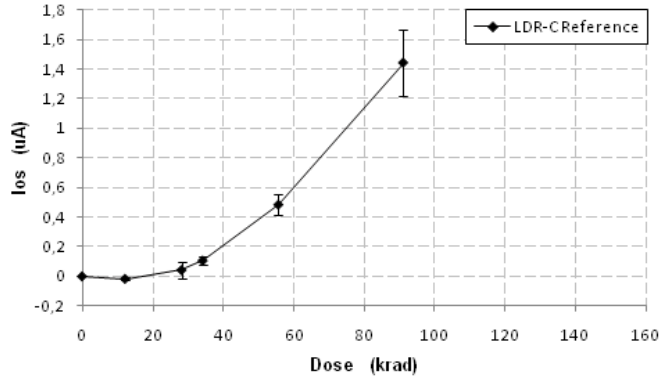

Raw Data		Device Type: LM324AN		Parameter: Avo (dB)		Biasing Condition: Unbiased	
LDR-C Reference	Dose (krad)	0.00	12.16	28.19	34.17	55.61	90.95
	BRef1	113.2	94.94	75.24	74.46	66.15	60.16
	BRef2	116.4	95.79	75.75	75.49	67.46	61.31
	BRef3	113	97.78	76.56	76.41	68.11	62.47
	BRef4	114.3	94.83	74.89	74.48	66.47	60.56
	BRef5	113.1	95.11	74.54	74.02	66.3	60.56
	Mean	114	95.69	75.39	74.97	66.89	61.01
	StdDev	1.44	1.22	0.78	0.96	0.84	0.91

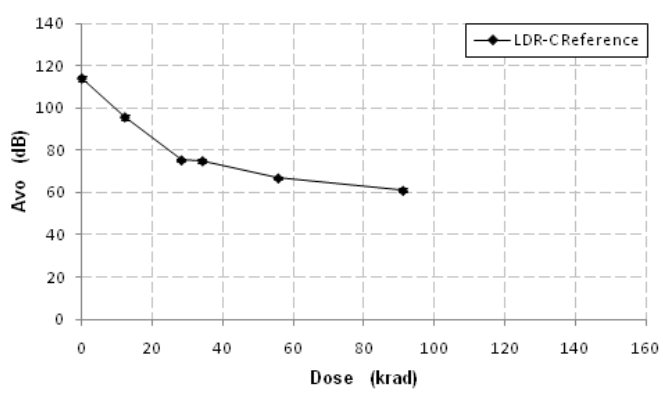

Raw Data	Device Type: LM324AN	Parameter: CMRR (dB)	Biasing Condition: Unbiased				
LDR-C Reference	Dose (krad)	0.00	12.16	28.19	34.17	55.61	90.95
	BRef1	100.3	97.94	91.89	78.98	69.89	65.52
	BRef2	96.89	95.77	94.74	79.42	71.27	65.27
	BRef3	99.66	99.12	94.29	80.74	72.13	66.01
	BRef4	99.64	96.78	93.97	78.6	69.89	64.04
	BRef5	97.71	96.56	94.03	78.15	69.34	64.02
	Mean	98.84	97.23	93.78	79.17	70.50	64.97
	StdDev	1.45	1.30	1.10	0.99	1.15	0.90

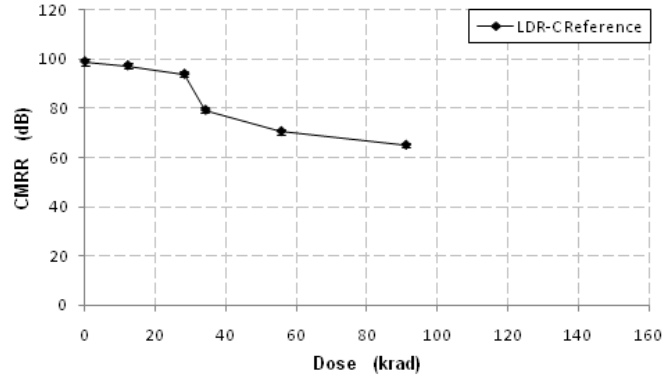

Raw Data	Device Type: LM324AN	Parameter: PSRR (dB)	Biasing Condition: Unbiased				
LDR-C Reference	Dose (krad)	0.00	12.16	28.19	34.17	55.61	90.95
	BRef1	102.5	87.02	66.94	65.01	58.8	54.75
	BRef2	102.3	87.8	67.44	65.25	58.7	54.88
	BRef3	103.1	89.16	68.2	66.14	59.81	56.07
	BRef4	101.3	87.34	67.12	65.42	58.86	55.11
	BRef5	99.32	87.43	67.04	65.38	59.01	55.07
	Mean	101.70	87.75	67.34	65.44	59.03	55.17
	StdDev	1.48	0.83	0.51	0.42	0.44	0.52

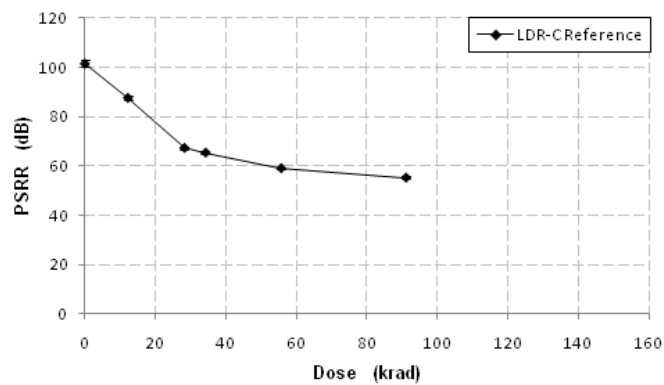

Raw Data	Device Type: LM324AN	Parameter: PSSR- (dB)	Biasing Condition: Unbiased				
LDR-C Reference	Dose (krad)	0.00	12.16	28.19	34.17	55.61	90.95
	BRef1	104.9	96.07	83.46	73.09	65.85	60.91
	BRef2	101.8	94	82.77	73.54	66.15	61.38
	BRef3	103.9	98.04	84.01	74.54	67.76	63
	BRef4	103	95.97	83.22	73.92	65.94	61.04
	BRef5	101.4	94.44	83.79	73.52	66.02	61.33
	Mean	103	95.70	83.45	73.72	66.34	61.53
	StdDev	1.45	1.59	0.48	0.54	0.79	0.84

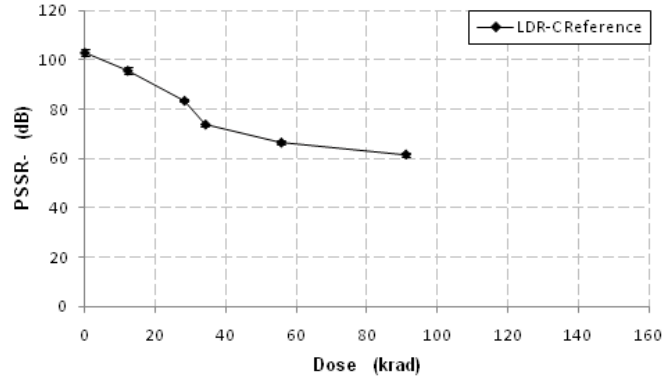

Raw Data	Device Type: LM324AN	Parameter: Vo+ (V)	Biasing Condition: Unbiased				
LDR-C Reference	Dose (krad)	0.00	12.16	28.19	34.17	55.61	90.95
	BRef1	13.8	13.81	13.83	13.82	13.82	13.82
	BRef2	13.8	13.81	13.83	13.82	13.82	13.82
	BRef3	13.8	13.81	13.83	13.81	13.82	13.82
	BRef4	13.8	13.81	13.83	13.82	13.82	13.82
	BRef5	13.8	13.82	13.83	13.82	13.82	13.82
	Mean	13.8	13.81	13.83	13.81	13.82	13.82
	StdDev	0.00	4.47E-03	1.98E-15	4.47E-03	1.98E-15	1.98E-15

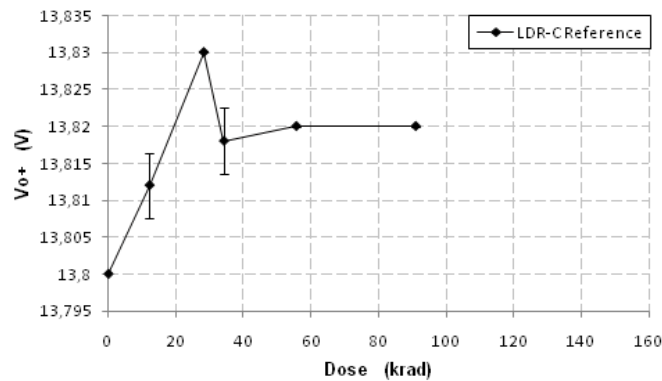

Raw Data — Device Type: LM324AN Parameter: Vo- (V) Biasing Condition: Unbiased

LDR-C Reference	Dose (krad)	0.00	12.16	28.19	34.17	55.61	90.95
	BRef1	-14.97	-14.95	-14.94	-14.94	-14.94	-14.93
	BRef2	-14.97	-14.95	-14.94	-14.94	-14.94	-14.93
	BRef3	-14.96	-14.96	-14.95	-14.94	-14.94	-14.93
	BRef4	-14.97	-14.95	-14.94	-14.94	-14.94	-14.93
	BRef5	-14.97	-14.96	-14.94	-14.94	-14.94	-14.93
	Mean	-14.96	-14.95	-14.94	-14.94	-14.94	-14.93
	StdDev	4.47E-03	5.47E-03	4.47E-03	1.98E-15	1.98E-15	1.98E-15

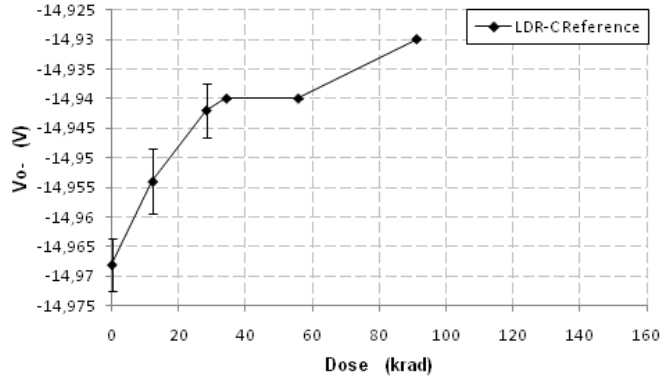

Raw Data — Device Type: LM324AN Parameter: Isc+ (mA) Biasing Condition: Unbiased

LDR-C Reference	Dose (krad)	0.00	12.16	28.19	34.17	55.61	90.95
	BRef1	42.2	41.3	40.57	40.69	40.22	39.72
	BRef2	42.57	41.78	41.03	41.23	40.72	40.29
	BRef3	42.79	41.92	41.32	41.35	40.92	40.48
	BRef4	42.64	41.74	41.03	41.13	40.69	40.29
	BRef5	42.36	41.45	40.83	40.94	40.47	39.99
	Mean	42.51	41.63	40.95	41.06	40.60	40.15
	StdDev	0.23	0.25	0.27	0.25	0.26	0.29

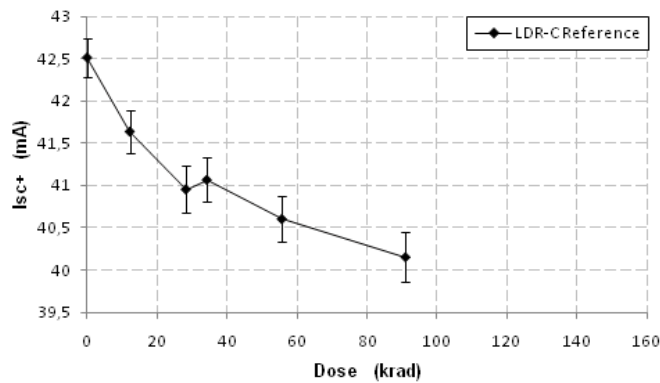

Raw Data	Device Type: LM324AN	Parameter: Isc- (mA)	Biasing Condition: Unbiased				
LDR-C Reference	Dose (krad)	0.00	12.16	28.19	34.17	55.61	90.95
	BRef1	-33.78	-24.51	-17.48	-16.28	-12.43	-9.90
	BRef2	-34.12	-25.23	-18.09	-16.97	-12.94	-10.5
	BRef3	-34.42	-25.55	-18.55	-17.23	-13.32	-10.77
	BRef4	-33.8	-24.42	-17.29	-16.09	-12.34	-9.85
	BRef5	-33.44	-24.06	-17.12	-15.94	-12.12	-9.63
	Mean	-33.91	-24.75	-17.70	-16.50	-12.63	-10.13
	StdDev	0.37	0.61	0.59	0.56	0.48	0.47

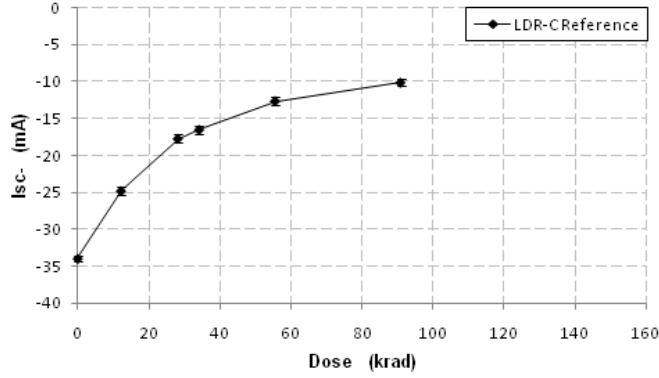

Raw Data	Device Type: LM324AN	Parameter: SR (V/μsec)	Biasing Condition: Unbiased				
LDR-C Reference	Dose (krad)	0.00	12.16	28.19	34.17	55.61	90.95
	BRef1	0.02	0.16	0.06	0.04	0.02	0.00
	BRef2	0.30	0.16	0.06	0.05	0.02	0.00
	BRef3	0.30	0.16	0.06	0.05	0.02	0.01
	BRef4	0.29	0.15	0.05	0.04	0.01	0.00
	BRef5	0.29	0.15	0.05	0.04	0.02	0.00
	Mean	0.24	0.16	0.06	0.04	0.02	0.00
	StdDev	0.12	0.00	4.63E-03	4.03E-03	2.82E-03	2.23E-03

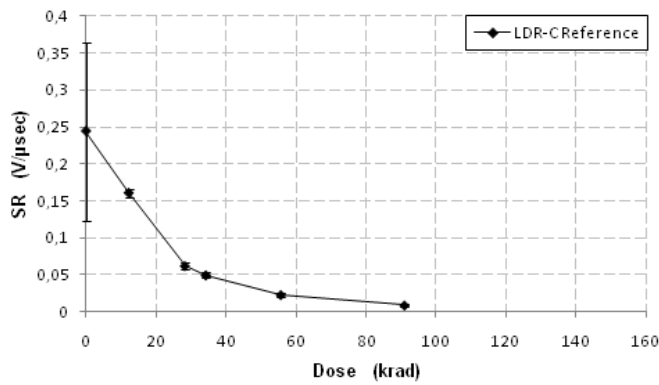

## **Contact**

**AIT Austrian Institute of Technology GmbH**  
Donau-City-Straße 1, 1220 Wien, Austria

[www.ait.ac.at](http://www.ait.ac.at)  
Fax +43 (0) 50550-2201

**Dr. Peter Beck**  
Nanodosimetry  
+43 (0) 50550-4305  
[hubert.brueckl@ait.ac.at](mailto:hubert.brueckl@ait.ac.at)

**Mag. Dr. Susanne Kiefer**  
Marketing  
+43 (0) 50550-3579  
[susanne.kiefer@ait.ac.at](mailto:susanne.kiefer@ait.ac.at)

**Mag. Shweta Kumar**  
Sekretary  
+43 (0) 50550-4300  
[Kerstin.formanek@ait.ac.at](mailto:Kerstin.formanek@ait.ac.at)